

《2014》

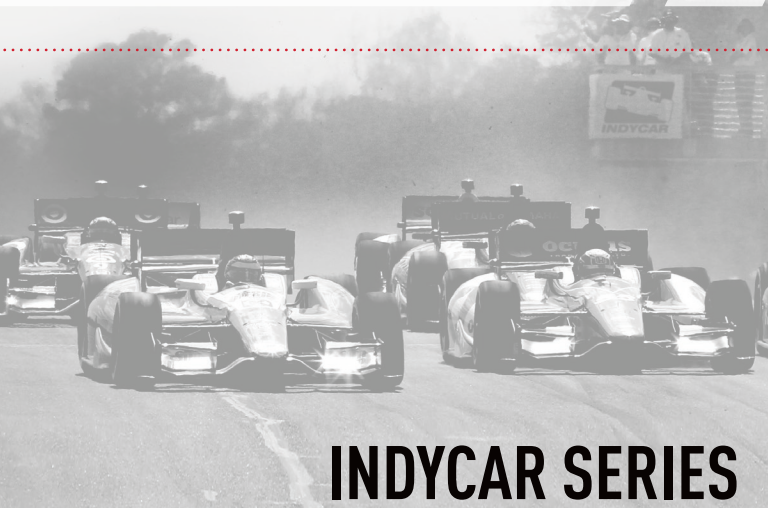

**INDYCAR SERIES**  
**OFFICIAL RULE BOOK**

# TABLE OF CONTENTS

<b>1. GENERAL .....</b>	<b>8</b>
1.1. GOVERNANCE .....	8
1.2. SAFETY .....	13
1.3. LOGO DISPLAY .....	22
1.4. ADVERTISING .....	22
1.5. PRODUCT USE.....	23
1.6. EVENT ACTIVITIES .....	24
<b>2. MEMBERSHIP .....</b>	<b>30</b>
2.1. GENERAL .....	30
2.2. APPLICATION .....	30
2.3. TERM .....	32
2.4. INTERIM REVIEW OF QUALIFICATIONS.....	32
2.5. ACKNOWLEDGEMENT OF RELEASE AND ASSUMPTION OF RISK.....	32
2.6. APPLICABLE LAWS AND JURISDICTION .....	32
2.7. CONDUCT IDENTIFICATION.....	34
2.8. LITIGATION.....	34
2.9. CATEGORIES .....	34
2.10. AGE .....	34
2.11. MORAL FITNESS .....	34
2.12. PHYSICAL AND PSYCHOLOGICAL FITNESS.....	35
2.13. MEDICAL EXAMINATIONS AND TREATMENT .....	36
2.14. DETERMINATION OF FITNESS.....	37
2.15. WAIVER OF CLAIMS .....	37
2.16. PENALTIES.....	37

2.17. VIOLATION OF LAWS .....	38
2.18. MEDICAL RECORDS .....	38
2.19. MEMBERSHIPS, LICENSES AND CREDENTIALS .....	39
<b>3. SANCTIONS.....</b>	<b>41</b>
3.1. PROMOTION OF RACES .....	41
3.2. EVENT PROMOTER RESPONSIBILITIES .....	41
3.3. RESTRICTIONS .....	42
<b>4. ENTRANTS/DRIVER REGULATIONS .....</b>	<b>43</b>
4.1. GENERAL .....	43
4.2. ENTRANT LICENSE.....	45
4.3. DRIVER LICENSE .....	48
4.4. COMMUNICATION .....	52
4.5. CAR REGISTRATION .....	54
<b>5. ENTRIES.....</b>	<b>60</b>
5.1. GENERAL .....	60
5.2. FEES.....	63
5.3. DEADLINE .....	63
5.4. ELECTRONIC ENTRIES.....	63
5.5. REOPENING OF ENTRIES .....	63
5.6. FAILURE TO PARTICIPATE.....	64
5.7. ENTRY CHANGE .....	64
5.8. POINTS AND AWARDS.....	64
<b>6. TESTING.....</b>	<b>65</b>
6.1. GENERAL .....	65
6.2. APPROVED TESTING .....	66
6.3. INDYCAR-APPROVED VENUES .....	68
6.4. TESTING PERIODS .....	69

6.5. ADDITIONAL TESTING RESTRICTIONS.....	70
<b>7. AT TRACK PROCEDURES .....</b>	<b>71</b>
7.1. ON TRACK CONDITIONS .....	71
7.2. FLAG CODES (“FLAGS”) .....	76
7.3. TIMING AND SCORING .....	80
7.4. PIT LOCATIONS/SELECTION.....	84
7.5. RACE START.....	87
7.6. RACE RESTART .....	92
7.7. MECHANICAL CONDITIONS .....	95
7.8. PERFORMANCE STANDARDS.....	96
7.9. PIT PROCEDURES .....	96
7.10. PIT SAFETY VIOLATIONS .....	98
<b>8. QUALIFICATIONS .....</b>	<b>100</b>
8.1. ALL RACE LOCATIONS .....	100
8.2. OVALS .....	105
8.3. ROAD/STREET COURSES .....	111
8.4. INDIANAPOLIS 500® MILE RACE – TO BE ISSUED BY BULLETIN. ....	116
<b>9. PENALTIES .....</b>	<b>117</b>
9.1. GENERAL .....	117
9.2. SCOPE OF PENALTIES .....	117
9.3. ADDITIONAL PROVISIONS AND GUIDELINES.....	122
<b>10. CHAMPIONSHIP, POINTS &amp; POINTS FUND .....</b>	<b>126</b>
10.1. CHAMPIONSHIPS AND POINT STANDINGS .....	126
10.2. SIGNIFICANCE OF THE CAR NUMBER.....	126
10.3. CREDITING OF POINTS .....	126
10.4. TIES .....	127

10.5. END OF SEASON POINTS FUND.....	128
10.6. POINTS.....	128
<b>11. AWARDS.....</b>	<b>130</b>
11.1. APPROVAL.....	130
11.2. AWARDS.....	130
11.3. WITHHOLDING.....	130
<b>12. PROTESTS .....</b>	<b>132</b>
12.1. SUBMISSION OF PROTESTS.....	132
12.2. PROTEST .....	132
12.3. INFORMAL INQUIRY.....	133
12.4. RIGHT TO PROTEST AND TIME LIMITS .....	133
12.5. JURISDICTION.....	138
12.6. ADVISORY COMMITTEE .....	138
12.7. HEARING OF THE PROTEST.....	139
12.8. CONDUCT OF THE PROTEST HEARING.....	139
12.9. UNUSUAL CIRCUMSTANCES .....	140
12.10. DETERMINATION OF THE PROTEST .....	140
12.11. PROTEST PROCEDURE FINAL .....	141
12.12. COMPLIANCE WITH PROCEDURES.....	141
<b>13. APPEALS .....</b>	<b>142</b>
13.1. SUBMISSION OF APPEALS .....	142
13.2. APPEAL.....	142
13.3. RIGHT TO APPEAL AND TIME LIMITS .....	143
13.4. JURISDICTION.....	144
13.5. ADVISORY COMMITTEE .....	144
13.6. HEARING OF THE APPEAL .....	144
13.7. CONDUCT OF THE APPEAL HEARING .....	145

13.8. STRUCTURE OF THE APPEAL HEARING .....	146
13.9. POWERS OF THE APPEAL OFFICIAL .....	147
13.10. DETERMINATION OF THE APPEAL .....	148
13.11. APPEAL PROCEDURE FINAL .....	148
13.12. COMPLIANCE WITH PROCEDURES.....	149
<b>14. TECHNICAL SPECIFICATIONS .....</b>	<b>150</b>
14.1. GENERAL .....	150
14.2. TECHNICAL INSPECTION .....	151
14.3. CAR WEIGHT AND DRIVER EQUIVALENCY WEIGHT ....	154
14.4. CHASSIS.....	156
14.5. DIMENSIONS.....	162
14.6. AERODYNAMICS .....	163
14.7. FUEL SYSTEM.....	184
14.8. STEERING AND SUSPENSION.....	185
14.9. DAMPERS.....	186
14.10. DRIVESHAFTS / HUBS .....	187
14.11. SUSPENSION WHEEL/WING ENERGY MANAGEMENT SYSTEM (SWEMS).....	187
14.12. BRAKES.....	188
14.13. WHEELS.....	189
14.14. ENGINE.....	190
14.15. TRANSMISSION/DIFFERENTIAL .....	191
14.16. AIRJACK .....	192
14.17. ELECTRONICS .....	192
14.18. FUEL .....	198
14.19. REFUELING .....	199
<b>15. TIRES .....</b>	<b>202</b>
15.1. GENERAL TIRE RULES .....	202

15.2. TIRE ALLOTMENTS .....	202
15.3. RACE TIRE RULES.....	205
15.4. PRACTICE TIRE RULES .....	206
<b>16. ENGINE SPORTING REGULATIONS .....</b>	<b>207</b>
16.1. GENERAL .....	207
16.2. FULL-SEASON MILEAGE LIMIT .....	208
16.3. ENGINE CHANGE-OUT .....	209
16.4. ENGINE REPAIR .....	209
16.5. APPROVED ENGINE CHANGE-OUTS .....	210
16.6. UNAPPROVED ENGINE CHANGE-OUTS.....	213
16.7. DOWN ON POWER ENGINES.....	215
16.8. SINGLE RACE EVENT ONLY PROGRAM.....	217
<b>17. EQUIPMENT &amp; GARAGES .....</b>	<b>218</b>
17.1. FUEL STORAGE TANKS .....	218
17.2. PIT LANE FIRE EQUIPMENT .....	224
17.3. EQUIPMENT.....	225
17.4. GARAGE.....	225
17.5. COVERS .....	226
<b>18. GLOSSARY .....</b>	<b>228</b>

# **2014 INDYCAR SERIES RULE BOOK**

## **PREFACE**

The Rules apply to the 2014 IndyCar Series Events. Each Member has been provided with or has been given access to a copy of the Rules, is deemed to have a full awareness and understanding of the Rules, and has agreed to abide by and be personally responsible for compliance with the Rules.

Further information may be obtained by contacting the INDYCAR offices at 4551 West 16th Street, Indianapolis, IN 46222, Telephone (317) 492-6526.



# 1. GENERAL

## 1.1. Governance

### 1.1.1. General

**1.1.1.1.** The Rules govern the 2014 IndyCar Series Events and supersede all previous Rules, bulletins and supplementary Rules and regulations, unless otherwise indicated. Capitalized terms used in the Rules have the meanings set forth in Chapter 18, Glossary.

**1.1.1.2.** Each Member is personally responsible for the Member's compliance with the Rules.

**1.1.1.3.** INDYCAR may penalize any Member and/or exclude any Member or equipment from any Event if INDYCAR deems any act, any omission, any condition to be hazardous and/or not meeting the specifications, requirements, spirit, illustrations, and/or intent of, the Rules. Acts, omissions or conditions that may warrant penalty and/or exclusion include without limitation any action which INDYCAR deems to be a threat to or a violation of the integrity or safety of INDYCAR, the IndyCar Series and/or orderly conduct of the Event, and/or which relates to the design or construction of a Car or repairs to a damaged Car.

**1.1.1.4.** If the Rules do not expressly permit a variation, then the Member shall presume that such variation is not permitted. If a Member is uncertain if an act, part, etc. violates a Rule, the burden is on the Member to receive pre-approval in writing from

INDYCAR. For this purpose, e-mails are not written approval unless otherwise expressly permitted and specified by INDYCAR by bulletin. If not, the Member assumes the risk of noncompliance. Failure to gain an advantage by a Rule violation may not reduce or negate a penalty.

### **1.1.2. INDYCAR Authority**

**1.1.2.1.** The Rules shall be applied, constructed, and interpreted by INDYCAR, and INDYCAR's application, construction, and interpretation shall be final and binding.

**1.1.2.2.** INDYCAR reserves the right to revise the Rules at any time, including, without limitation, prior to or during an Event. Notices, bulletins, supplementary Rules, regulations, and penalties are effective on the date and time issued, regardless of the date and time when a Member receives actual notice.

**1.1.2.3.** INDYCAR shall have the right (i) to authorize and supervise Events of any kind; (ii) to create, interpret, revise and enforce Rules at any time and (iii) to render decisions concerning the Rules and Events; (iv) to grant, approve, refuse, enforce or withdraw Licenses, memberships, and sanctions; (v) to assign and cancel dates for Events; (vi) to appoint and rescind the appointment of Officials; (vii) to impose, enforce and or remove penalties for any violation of the Rules; (ix) to establish, interpret and enforce standards of eligibility for participation in Events; (x) to establish Rules for its own procedure; and to do any and all things which, in its judgment, are consistent with the enhancement, safety and/or integrity of the Events. INDYCAR also reserves the right to take whatever action and/or

impose whatever penalty it deems necessary to maintain the integrity and safety of INDYCAR, the IndyCar Series, and/or its Events.

### **1.1.3. Officiating**

**1.1.3.1.** INDYCAR will select Officials, as it deems appropriate.

**1.1.3.2.** INDYCAR shall have the authority to take any actions and make any determinations it deems necessary or appropriate during, or in connection with, an Event including without limitation determinations as to whether a Rule violation has occurred, whether a penalty should be imposed, the specifications of any penalty and the enforcement of any penalty.

**1.1.3.3.** INDYCAR shall have the right to determine whether or not to publically publish or cause to be publically published a notice stating that INDYCAR has penalized any Member and/or rendered a judgment on a protest and/or appeal. If published, the notice may include without limitation a description of the penalty or judgment and names of the affected Member(s). Having accepted the privileges and obligations of membership, the Members referenced in any such notice waive any and all rights of action against INDYCAR and/or against any individual or entity publishing such notice. INDYCAR may without limitation publicize the results referenced in such notice in the posting and awards or otherwise.

**1.1.3.4.** INDYCAR will secure necessary timing and scoring and technical equipment and record all timing and scoring information and technical information, including the standings of an Event; (i)

control the designated timing and scoring and technical areas; (ii) provide competition information to the Competitors, the Event Promoter, and the press; (iii) and facilitate the award distributions. INDYCAR shall be the final authority on the content of the official posting of all Entry lists, practice sessions, qualifications results, Race finishes, point standings, and award distributions.

**1.1.3.5.** INDYCAR may without limitation order the completion, postponement, or cancellation of any Event or any portion thereof in the case of inclement weather, physical condition of the Track, or for any other reason. INDYCAR may terminate a Race before its scheduled number of laps or allotted time and in such case determine the Race results and disposition of the awards, and may terminate a Race after one or more Cars have finished. INDYCAR may increase or reduce the scheduled number of laps or allotted time, or they may declare an Event completed, postponed, terminated or abandoned.

**1.1.3.6.** As soon as practical after the conclusion of an Event, INDYCAR shall prepare a report giving the results of the Event and may identify protests lodged and any penalty administered. INDYCAR shall keep a record of Cars declared out of the Race and the reason therefor.

#### **1.1.4. Acceptance of the Rules**

**1.1.4.1.** Every Member who is involved in and/or participates in any way in any Event shall be deemed to have a full awareness and understanding of, and to have accepted, the Rules.

**1.1.4.2.** Every Member agrees to follow the direction of INDYCAR with respect to the enforcement and

interpretation of these Rules or be subjected to penalties for failure to comply with such directions.

### **1.1.5. Assumption of Risk, Liability Release, Acknowledgment and Indemnity**

**1.1.5.1. ASSUMPTION OF RISK** - EVERY MEMBER AGREES TO BE BOUND BY THE RULES AND ASSUMES ALL OF THE RISK OF SUCH MEMBER'S INVOLVEMENT AND/OR PARTICIPATION IN AN EVENT.

**1.1.5.2. LIABILITY RELEASE** - RECOGNIZING THAT AUTOMOBILE RACING CAN BE A HAZARDOUS UNDERTAKING, MEMBERS, FOR THEMSELVES, THEIR HEIRS, EXECUTORS, REPRESENTATIVES, SUCCESSORS AND ASSIGNS, AGREE, BY THEIR MEMBERSHIP, THAT THEY RELEASE AND DISCHARGE INDYCAR, FIA, ACCUS-FIA, EVENT PROMOTORS, OTHER MEMBERS AND THE OFFICERS, DIRECTORS, EMPLOYEES, AGENTS, AFFILIATES, REPRESENTATIVES, OWNERS, SUCCESSORS AND ASSIGNS OF EACH OF INDYCAR GROUP FROM ANY AND ALL LIABILITY FOR DAMAGES TO PROPERTY, PERSONAL INJURY, AND/OR DEATH, IN ANY WAY RELATING TO ANY EVENT OR THE MEMBERS' INVOLVEMENT AND/OR PARTICIPATION IN THE EVENT, REGARDLESS OF HOW THE CLAIM MIGHT ARISE INCLUDING WITHOUT LIMITATION RACE OFFICIATING, RULE INTERPRETATION AND VIOLATIONS, PHYSICAL CONDITION OF THE TRACK, AND/OR EMERGENCY TREATMENT OR RESCUE.

### **1.1.5.3. ACKNOWLEDGEMENT**

**1.1.5.3.1.** MEMBERS RECOGNIZE THIS RELEASE APPLIES EVEN IF THE RELEASED INDYCAR

GROUP OR ANY OF THEM ACTED NEGLIGENTLY AND UNDERSTAND THAT MEMBERS MAY BE ASKED TO ACKNOWLEDGE THIS ASSUMPTION OF RISK AND RELEASE BY OTHER AGREEMENTS THEY MIGHT SIGN AS A PREREQUISITE TO PARTICIPATE IN AN EVENT OR EVENTS.

**1.1.5.3.2.** EACH MEMBER ACKNOWLEDGES THAT THE MEMBER HAS MADE THE MEMBER'S SPOUSE AND/OR DEPENDENTS AWARE OF THE MEMBER'S DECISION TO ASSUME AND INCUR THE RISK ASSOCIATED WITH RACING WITHOUT THE RIGHT TO PURSUE CLAIMS OF WRONGDOING.

**1.1.5.4. INDEMNITY** – EACH MEMBER ACKNOWLEDGES THAT MEMBER IS RESPONSIBLE FOR VIOLATION OF MEMBER'S AGREEMENTS BY MEMBER, MEMBER'S REPRESENTATIVES INCLUDING LOVED ONES AFFECTED BY MEMBER'S PARTICIPATION, AND MEMBER'S PARTICIPANTS AND GUESTS. THIS RESPONSIBILITY APPLIES TO ALL VIOLATIONS OF MEMBER'S AGREEMENTS WITH INDYCAR. THIS INCLUDES THE MISUSE OF CREDENTIALS AND THE FAILURE TO ACCEPT THE ASSUMPTION OF RISK, THE WAIVER AND RELEASE OF LIABILITY, THE BINDING NATURE OF THE RULES, INDYCAR'S INTERPRETATION OF THE RULES, AND THE FINALITY OF THE APPEAL PROCEDURE. MEMBER UNDERSTANDS THAT THIS RESPONSIBILITY INCLUDES THE DUTY TO INDEMNIFY AND HOLD INDYCAR GROUP HARMLESS FROM THE CONSEQUENCES AND DAMAGES ARISING FROM THE VIOLATION.

## **1.2. Safety**

**1.2.1. Safety Policy** - While INDYCAR seeks to maintain safe conditions for Competitors and other Members taking into account all aspects of the Event, Members recognize that conditions may not be safe and can be affected by human error. At any Event each Member acknowledges and agrees that racing is a hazardous activity and their participation is with expressed assumption of this risk.

**1.2.1.1.** While acknowledging the inherent risk of racing to Competitors and other Members participating in an Event, Members are personally responsible for their own safety, for the safety of each Member of Member Group and for the safety of their racing equipment. No Event Promoter, INDYCAR, or any Manufacturer is responsible for the adequacy of any Member's racing equipment or racing activity to accomplish this purpose. No Event Promoter, INDYCAR, or any Manufacturer makes any representation, express warranty, implied warranty or covenant that safety equipment and/or personnel will prevent or reduce the Member's risk or extent of injury in any Event.

**1.2.1.2.** INDYCAR may take any action including canceling, postponing, temporarily stopping or delaying an Event, if INDYCAR determines that basic safety requires such action. INDYCAR may order off the Track any Member or Car that INDYCAR determines constitutes a hazard. INDYCAR may but is not required to, prohibit any Member or Member's equipment from entering or continuing in an Event if INDYCAR considers the Member's acts or omissions to be negligent, reckless or hazardous or that the Member is acting without due consideration to others. None of such decisions during an Event may be protested and/or appealed. In the event a Driver is ordered off the Track due solely to driving, the Entrant may replace the Driver with a qualified

Driver approved by INDYCAR and continue in the Event.

## **1.2.2. Security**

- 1.2.2.1.** Only authorized individuals are permitted on the Track and other locations designated by INDYCAR or an Event Promoter including without limitation spotter stands, corner worker stations, safety truck locations, photographer locations, and broadcast platforms.
- 1.2.2.2.** INDYCAR and the Event Promoter have the right to engage in such searches of individuals and property at any Race Location, as they deem necessary or appropriate for the safety and security of the Event. If they deem necessary, INDYCAR and the Event Promoter have the right but are not required to remove any individual and/or property from the Race Location.
- 1.2.2.3.** INDYCAR may but are not required to penalize any Entrant, Associate, or other Member whose representative or equipment enters a restricted area at any Race Location prior to the scheduled opening time or remains in a restricted area at an Race Location after the scheduled closing time without prior approval from INDYCAR and the Event Promoter.
- 1.2.2.4.** Only Members possessing a valid Driver's license may operate a motorized vehicle in a restricted area during an Event. Only INDYCAR-approved vehicles are permitted in the pit area. INDYCAR and/or an Event Promoter may have additional or different requirements for a particular Event, and INDYCAR may modify the foregoing Rule accordingly.



- 1.2.2.5.** Members must not operate or permit another individual to operate a motorized or non-motorized vehicle at the Race Location negligently, recklessly or without due consideration to Members, spectators or others.
- 1.2.2.6.** Smoking is not permitted on the Track, in the pit area, or in any fuel service area. INDYCAR and/or an Event Promoter may have additional or different requirements for a particular Event, and INDYCAR may modify the foregoing Rule to the extent permitted or required by law.
- 1.2.2.7.** The use or possession of illegal or unauthorized weapons or substances of any sort by a Member during an Event is prohibited.

### **1.2.3. Medical/Rescue Requirements and Injury Reports**

- 1.2.3.1.** INDYCAR may require the Event Promoter to use, in compliance with local regulations and/or FIA requirements, medical/rescue personnel and equipment acceptable to INDYCAR to provide Members with assessment and treatment of emergency medical conditions including without limitation breathing difficulty, spinal injury, cardiopulmonary arrest, and external bleeding.
- 1.2.3.2.** A Driver may be required to demonstrate ability to exit the Car to INDYCAR's satisfaction by a method as determined by INDYCAR.
- 1.2.3.3.** A Driver involved in a crash or injured in another incident during an Event must report as directed by INDYCAR and may neither continue in the Event nor participate in future Events without clearance from INDYCAR.

**1.2.3.4.** Any other Member involved in a crash or injured in another incident during an Event must report to the medical center or as directed by INDYCAR before departing the Race Location prior to the conclusion of the Event.

**1.2.4. Biomedical Research and Device Testing Policy**– All Members must comply with INDYCAR’s Biomedical Research and Device Testing Policy available from the INDYCAR office.

**1.2.5. Data Sharing Policy - All Members agree:**

**1.2.5.1.** INDYCAR owns all data and information collected by or on behalf of INDYCAR, including without limitation, all data from broadcast telemetry, in-car cameras, impact recorders, and earpieces.

**1.2.5.2.** INDYCAR may disclose the data to third parties for any purpose including, without limitation, safety and/or medical research.

**1.2.5.3.** If an individual desires to receive any such data from INDYCAR, the individual shall submit a request in writing to the President of Competition and Operations.

**1.2.5.3.1.** The written request shall specify the data requested and the proposed use of the data.

**1.2.5.3.2.** INDYCAR shall determine whether to provide the data, taking into account such factors as the nature of the data requested, the uses for which the individual requests the data and whether or not consent and/or approval of any other individual is required or appropriate in order to release the data.

**1.2.5.3.3.** The individual requesting the data will be required to execute an agreement regarding approved uses for the data and the confidential treatment of any data that INDYCAR approves for use by the individual.

**1.2.5.4.** Notwithstanding the foregoing, an Entrant may record its own pit stop activities from its own pit area during Events for use only by such Entrant for internal evaluation of its own pit stop procedures. All other activities and/or uses require prior INDYCAR written approval.

**1.2.6. Safety Inspections** - INDYCAR may inspect all equipment prior to each Event and re-inspect equipment at any time including, without limitation, before, during or after each Event. An Entrant may be required to replace without limitation seats, seat belts, helmets, headrests, head restraint systems, and other equipment at any time, as determined by INDYCAR.

### **1.2.7. Personal Safety Equipment**

**1.2.7.1. Drivers** - All Drivers must wear:

- a) Fire resistant one piece uniform conforming to SFI 3.2A/5 or FIA 8856-2000 specifications;
- b) Fire resistant socks;
- c) Fire resistant shoes;
- d) Fire resistant gloves;
- e) Nomex underwear long sleeve tops and full length bottoms;
- f) Fire resistant head sock.

**1.2.7.1.1.** All removable dental appliances, chewing gum, rings, watches and other jewelry and comparable items should be removed before a Driver participates in any on-Track Event.

**1.2.7.1.2. Helmets** - All Drivers must wear safety helmets designed specifically for automobile racing that meet or exceed the FIA 8860-2010 specification. Helmets must be spherical in shape and be fitted with a face shield that has an INDYCAR-approved positive latching mechanism designed to keep the shield down in the event of a crash. Aerodynamic devices must not protrude more than 0.250 inches from the surface outside of the shaded area shown below. Inside the shaded area a 0.500 inch high device is allowed. Flat back designs are not permitted. All helmets must be fitted with the approved removal system.

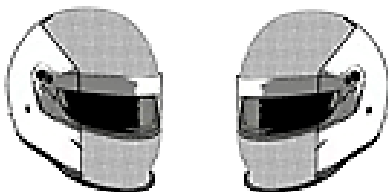

**1.2.7.1.2.1.** The visor shall be fitted with a reinforcement panel in accordance with the 2011 F1 VISOR REINFORCEMENT PANEL FOR FIA 8860 HELMET specification. The original visor, before the reinforcement panel is fitted, shall be certified with the helmet to FIA 8860-2010.

**1.2.7.1.3.** All helmets must be inspected and approved by INDYCAR before use and are subject to confiscation and re-inspection by INDYCAR at any time, including, without limitation, before, during or after each Event. INDYCAR shall affix stickers to the helmets signifying approval for use. At any time, including, without limitation before, during or after each Event, Officials may remove the approval stickers and require the helmets to be re-inspected and refurbished by a certified helmet manufacturer before INDYCAR will consider them for re-approval. The helmet manufacturer must submit to INDYCAR documentation stating the refurbished helmet is approved for use in competition in accordance with the Rules.

**1.2.7.1.4. Head Restraint Systems-** INDYCAR requires the use of head restraint systems. Head restraint systems must meet or exceed FIA 8858-2010 certifications and be approved by INDYCAR.

**1.2.7.1.5.** INDYCAR shall issue a serial number to each head restraint system. At any time, INDYCAR may require the head restraint system to be re-inspected and refurbished by the FIA certified head restraint system manufacturer before INDYCAR will consider it for re-approval. The head restraint system manufacturer must submit to INDYCAR documentation stating that the head restraint system is approved by FIA for use in competition in accordance with the Rules.

**1.2.7.1.6. Ear Pieces** – All Drivers must wear INDYCAR-supplied instrumented earpieces. Earpieces must be presented to INDYCAR for

testing before each Event and upon request.  
Repair and/or replacement of the earpieces may be at the Driver's expense.

**1.2.7.2. Crew Members and Other Competitors Participating in a Pit Stop** – Over the wall crew members, and any Member physically participating in the refueling process and/or tire changing process during a pit stop shall wear:

- a) Fire resistant uniforms conforming to SFI 3.2 A/1 specifications;
- b) Fire resistant shoes;
- c) Fire resistant gloves;
- d) Nomex underwear long sleeve tops and full length bottoms;
- e) Fire resistant head sock (fuelers only);
- f) Full-face helmet (fuelers only); and
- g) INDYCAR-approved helmet  
(Over-the-wall Competitors only)

**1.2.7.3. Crew Members, Other Competitors, and Officials** - Except as provided in Rule 1.2.7.1 and Rule 1.2.7.2 all credentialed personnel on the trackside of pit lane must adhere to the following dress code:

- a) Long pants;
- b) Closed-toe shoes; and
- c) Shirts with sleeves (no tank tops).

**1.2.7.3.1.** This Rule does not apply to individuals in the pit area who are not Competitors or Officials or to any individuals in the garage area or non-restricted areas. INDYCAR and/or an Event Promoter may have additional or different requirements for a particular Event.

### **1.3. Logo Display**

**1.3.1.** All Members agree to comply with the 2014 INDYCAR Style Guide available from INDYCAR, including, without limitation, display of all required emblems on all uniforms, Cars and other equipment and/or use of all required equipment.

### **1.4. Advertising**

**1.4.1.** INDYCAR may regulate or deny the advertising of any product on equipment, apparel or otherwise in connection with a Member, INDYCAR, the IndyCar Series or any Event for any reason.

**1.4.2.** Advertising may not be displayed until it has been approved by INDYCAR. INDYCAR may disapprove advertising for any reason, including, without limitation, advertising which it determines is offensive, inappropriate, illegal, undignified, in conflict with any INDYCAR or Event Promoter sponsorship, potentially confusing or may detract from the interest in any Event and/or the integrity of INDYCAR and/or the IndyCar Series.

**1.4.3.** INDYCAR may require a Member to agree in writing with a policy statement regarding advertising of a particular product.

**1.4.4.** Product advertising must comply with all Rules, including without limitation, size.

## **1.5. Product Use**

**1.5.1.** A Member shall not make a false or potentially false public or private statement concerning any product used or said to have been used in any Event. An Entrant may be required to provide INDYCAR with an affidavit certifying product use. Display of an emblem on a Car or uniform does not constitute a statement concerning use.

**1.5.2.** INDYCAR may certify that a product was used at any Event(s). A product manufacturer desiring to have INDYCAR certify that its product was used in any Event(s) must follow the procedures outlined in Rule 1.5.

**1.5.3.** To be eligible to receive certification of product use, the product manufacturer must agree in writing to the following:

**1.5.3.1.** The product manufacturer must agree in writing to be bound by the Rules and must agree to be subject to penalty pursuant to the Rules.

**1.5.3.2.** Any product to be advertised as being used in any Event must be reported to INDYCAR in writing at least 30 days prior to the Event and approved for use by INDYCAR. The product advertised must be used during the Event, and its use must be checked and certified by INDYCAR.

**1.5.3.3.** Product manufacturers posting awards contingent on product use and the display of advertising during an Event must provide INDYCAR with a statement of the conditions at least 30 days prior to the Event. The product manufacturer shall provide INDYCAR with proof of award distribution in accordance with these conditions within 30 days of certification by INDYCAR of the product use.



**1.5.3.4.** Any advertisement of products and the related use of these products during an Event must be consistent with the facts as determined by INDYCAR and must not be likely to deceive, deceive, or mislead the public.

**1.5.3.5.** INDYCAR may add or revoke requirements, as it deems appropriate.

## **1.6. Event Activities**

**1.6.1. Activities** - INDYCAR may schedule mandatory meetings and/or activities for Members. INDYCAR may require a meeting with Member(s) at any time. Each Member must attend and actively participate in all official meetings and other activities designated by INDYCAR as mandatory for that Member at the times and locations designated by INDYCAR. These may include, but are not limited to the following:

### **1.6.1.1. Competition**

**1.6.1.1.1. Driver Meetings** - INDYCAR may conduct one or more meetings of Drivers to discuss general application, construction, and interpretation of the Rules and any specific Rules applying to a particular Event. Attendance at such meetings is limited to the Driver participating in the Event and any two of the following representatives for Entrant: owner, manager, chief mechanic, or spotter.

**1.6.1.1.2. Team Manager Meetings** - INDYCAR may conduct one or more meetings of team managers to discuss general application, construction, and interpretation of the operational or logistical Rules and any specific Rules applying to a particular Event.

### **1.6.1.1.3. Chief Mechanic Meetings -**

INDYCAR may conduct meetings of chief mechanics to discuss general application, construction, and interpretation of the technical Rules and any specific Rules applying to a particular Event.

## **1.6.1.2. Media**

### **1.6.1.2.1. Pre-Race Activities**

#### **1.6.1.2.1.1. Driver Autograph Sessions**

– INDYCAR may conduct one or more autograph sessions of Drivers during each Open Test and Race weekend.

**1.6.1.2.1.2. Practice** – Drivers must attend the fastest of the Day post-practice media center appearance.

**1.6.1.2.1.3. Qualifications** – Drivers must attend the following:

- a) Pole qualifying media “bullpen” appearance.
- b) Pole winner photograph obligations.

Immediately following qualifications, media center appearance:

- c) Oval Events: the Drivers starting in the first row.
- d) Road Course/Street Course Events: the Drivers participating in Segment Three.

**1.6.1.2.1.4. Pre-Race Ceremonies** - In preparation for a Race, Drivers shall follow the instructions of INDYCAR. Unless otherwise directed, the Drivers shall proceed to the Pre-Race stage and fully participate in Pre-Race ceremonies including without limitation any Driver introductions and/or Track laps.

**1.6.1.2.2. Post-Race Activities** - Upon completion of a Race, all Competitors shall follow the instructions of INDYCAR. Unless otherwise directed, the top three finishers in the Race shall proceed to victory lane as instructed by INDYCAR and fully participate in post-Race ceremonies including without limitation, not removing, obscuring, or otherwise altering any sponsor recognition. Specifically at a minimum, this includes the following:

**1.6.1.2.2.1.** The winning Driver must attend and participate in post-Race interviews in victory lane. The winning Driver and Car Owner of a Race agree to permit the display on the Car in victory lane, as designated by INDYCAR, one item from the series sponsor and one item from the Car's sponsor as determined by INDYCAR, including size, location, and placement of such item(s). The winning Entrant agrees to participate in a photograph session with the Event sponsor(s) and guests..

**1.6.1.2.2.2.** The 2<sup>nd</sup> through 5<sup>th</sup> place Drivers must stop in pit lane or such other area as designated by INDYCAR and participate in media interviews.

**1.6.1.2.2.3.** The 2<sup>nd</sup> and 3<sup>rd</sup> place Drivers must proceed to victory lane and join the Race winner in post-Race ceremonies. The top three finishers must wear INDYCAR provided hats in the following order: Firestone, IndyCar Series, and Engine Manufacturer.

**1.6.1.2.2.4.** Immediately following victory lane ceremonies, the winning Driver, 2<sup>nd</sup> place Driver and 3<sup>rd</sup> place Driver must attend and participate in post-Race interviews in the media center.

**1.6.1.2.2.5.** Following the media center interviews, the winning Driver shall attend and participate in a satellite media tour and radio media tour, if requested by INDYCAR

**1.6.1.2.2.6.** All other Drivers agree to attend and participate in the post-Race media center interview process, if requested by INDYCAR.

**1.6.1.2.2.7.** All selected Cars must be presented to Officials at technical inspection within one hour of the conclusion of the Race.

**1.6.1.2.3. Indianapolis 500® Mile Race** - All Drivers in the starting field must attend and actively participate in media events, at such times and locations as designated by INDYCAR, for a media day/photograph and videotape shoot, with travel provided by INDYCAR. The winning Driver must take the traditional drink of milk in victory lane. The winning Driver agrees

to attend and participate in a national media tour that may include a trip or trips to national media markets.

**1.6.1.2.4. Championship** - All Drivers and Entrants mathematically eligible to win the end of season Driver and/or Entrant point standings agree to attend and participate in activities as follows:

**1.6.1.2.4.1.** Race Location for final Race: a media activity approximately four weeks prior to the end of season Event.

**1.6.1.2.4.2.** During the final five (5) Races: designated pre-Race and/or post-Race media requirements, including national media teleconferences, satellite media tours and/or radio tours as directed by INDYCAR.

**1.6.1.2.4.3.** End of season Event week for final Race: a media event as designated by INDYCAR

**1.6.1.2.4.4.** IndyCar Series Champion: a national media tour that could include a trip or trips to national media markets, if requested by INDYCAR.

**1.6.1.2.5. Celebration** - The winning Car, Driver and Car owner must attend and participate in the celebration at such times and locations as designated by INDYCAR.

**1.6.2. Penalties** – INDYCAR shall determine whether a Member has failed to attend, failed to actively participate, or engaged in inappropriate conduct during

a meeting or mandatory activity. The following penalties may apply:

**1.6.2.1. First Offense** - \$5,000 and/or require attendance at an additional/substitute meeting and/or promotional appearances.

**1.6.2.2. Each Additional Violation** – INDYCAR may double the fine, require attendance at an additional/substitute meeting or meetings, or activity or activities, and/or INDYCAR may require the Driver's Car to start the Race at the rear of the starting field (in the case of a Drivers meeting).

**1.6.2.3.** Whether in attendance or not, Members shall be charged with knowledge of the matters discussed at all meetings (whether mandatory or not). A Member and the Member's Entrant waive the right to protest and/or appeal any penalties that may be assessed for any violation of the Rules if the Member was absent, did not actively participate or engaged in appropriate conduct at the meeting.

**1.6.2.4.** Unless otherwise approved by INDYCAR, no cellular telephones, wireless mobile devices, personal digital assistants or other recording devices may be used during any mandatory meeting and/or activity, except by INDYCAR or its designee.

## 2. MEMBERSHIP

### 2.1. General

**2.1.1.** INDYCAR is a voluntary membership organization. Each Member shall be deemed to be an independent contractor of INDYCAR, and the relationship between INDYCAR and a Member shall not be deemed to be a partnership, joint venture, an employment or a franchise relationship by virtue of the membership.

### 2.2. Application

**2.2.1.** Each applicant is required to submit the following properly executed materials for INDYCAR approval in the form required by INDYCAR:

**2.2.1.1.** Membership application on a form provided by INDYCAR,

**2.2.1.2.** Membership application fee (if any),

**2.2.1.3.** Substance Abuse Policy Authorization for Testing and Release (if the applicant is a designated Competitor or Official),

**2.2.1.4.** Participant Authorization for Use and Disclosure of Protected Health Information, and

**2.2.1.5.** Any other materials required by INDYCAR.

**2.2.2.** Qualifications for membership shall be determined by INDYCAR and may be periodically revised.

- 2.2.3.** Each applicant agrees to fulfill all contractual obligations such applicant and/or applicant's affiliates may have to INDYCAR, Event Promoters, Manufacturers, and their affiliates. Each applicant agrees that INDYCAR, Event Promoters, Manufacturers and their affiliates shall have the remedy of specific performance with respect to any and all such obligations in addition to all other rights and remedies available at law or in equity and notwithstanding any terms to the contrary in any other agreement.
- 2.2.4.** Each applicant must pay any and all outstanding financial obligations owed by applicant or its affiliates to INDYCAR, Manufacturers and their affiliates, or make other arrangements acceptable to INDYCAR, Manufacturers and their affiliates.
- 2.2.5.** INDYCAR shall determine whether to accept or reject any membership application, although the rejection of a membership application may be protested and/or appealed in accordance with the procedures set forth in Rule 12 and Rule 13.
- 2.2.6.** If an individual/entity participates in any Event without having properly submitted a fully-executed membership application, the individual/entity, by such participation, nevertheless agrees that the individual/entity is subject to all Rules bulletins, limitations of liability, indemnification and all statements, releases and obligations appearing in the membership application as if the individual/entity had properly submitted a fully-executed membership application.
- 2.2.7.** Regardless of where the application is executed by the applicant and/or accepted by INDYCAR and/or the credential issued, applicant recognizes and agrees that the Member's application and associated agreement is an Indiana contract and forms a contractual relationship



established in the State of Indiana and governed by the laws of Indiana. THIS CONTRACT AND RELATIONSHIP IS A LEGAL ONE AND APPLICANT SHOULD CONSULT HIS/HER ATTORNEY IF HE/SHE HAS ANY LEGAL QUESTIONS.

## **2.3. Term**

**2.3.1.** Unless otherwise determined by INDYCAR, a membership expires on December 31 of the calendar year. INDYCAR may issue a credential which may only be valid for a designated period or designated Event(s) as INDYCAR deems appropriate.

## **2.4. Interim Review of Qualifications**

**2.4.1.** INDYCAR may review the qualifications of a Member at any time after accepting a membership application to determine whether the Member shall continue to qualify for a membership under these Rules.

## **2.5. Acknowledgement of Release and Assumption of Risk**

**2.5.1.** INDYCAR may periodically request that a Member acknowledge the release, assumption of risk and indemnification provisions in the membership application, but the failure of INDYCAR to request and/or a Member to sign an acknowledgement does not negate the release, assumption of risk and indemnification provisions in the membership application or in these Rules.

## **2.6. Applicable Laws and Jurisdiction**

**2.6.1.** To avoid the need for specific inquiries, each Member represents, warrants and covenants to INDYCAR Group that such Member has complied with

and at all times will comply with all applicable local, state and federal, rules and regulations, including, without limitation, all laws related to taxes and fees, immigration, income/sales/use tax, safety/health, transportation, workers compensation, and frequency communications. Member further acknowledges and agrees to cooperate with INDYCAR's and its promoter's compliance obligations. For the avoidance of doubt, the Member's responsibilities include withholding and information reporting obligations required by law pursuant to Indiana House Enrolled Act 1544.

**2.6.2.** If there is a misrepresentation and/or a breach of the warranties and covenants in Rule 2.6.1, such Member shall indemnify and hold INDYCAR Group harmless from any loss or expense incurred by INDYCAR Group as a result of any noncompliance including without limitation, claims of INDYCAR Groups sole or contributory negligence and/or a claim that INDYCAR Group failed to supervise or achieve compliance.

**2.6.3.** The Rules shall be governed, interpreted and construed in accordance with the laws of the State of Indiana, without regard to its choice of law principals. All actions relating to the Rules shall be brought in state or federal court in Marion County, Indiana. Each Member consents to venue in and jurisdiction of the state of federal courts in Marion County, Indiana, and waives any rights to contest such venue and jurisdiction.

**2.6.4.** THE MEMBER WAIVES ANY RIGHT TO A TRIAL BY JURY IN ANY ACTION OR PROCEEDING TO ENFORCE OR DEFEND ANY RIGHTS UNDER THE RULES, AND AGREES THAT ANY SUCH ACTION OR PROCEEDING WILL BE TRIED BEFORE A COURT AS A BENCH TRIAL AND NOT BEFORE A JURY.

## **2.7. Conduct Identification**

**2.7.1.** A claim of intentional or willful and wanton conduct by one Member against another Member should never be made unless the claim can be supported by established facts. Even if factually supportable, such a claim cannot continue unless the notice required in the membership application is timely completed.

## **2.8. Litigation**

**2.8.1.** Each Member agrees to reimburse INDYCAR Group, and other named Members (INDYCAR Member Group) for all costs of litigation including without limitation travel expenses and attorneys' fees, costs and expenses if either of the following conditions occurs:

**2.8.1.1.** The Member initiates or otherwise causes a member of the INDYCAR Member Group to be named as a party in a legal proceeding not permitted or contemplated by the Rules;

**2.8.1.2.** The Member requests or compels a member(s) of the INDYCAR Member Group's participation in a manner other than as a party to the lawsuit.

## **2.9. Categories**

**2.9.1.** The following membership categories exist:

- |                     |                    |
|---------------------|--------------------|
| <b>a)</b> Entrant   | <b>d)</b> Official |
| <b>b)</b> Driver    | <b>e)</b> Media    |
| <b>c)</b> Associate | <b>f)</b> VIP      |

## **2.10. Age**

**2.10.1.** Before an individual shall be eligible for a membership or License and/or to participate in any Event, such individual must be at least 18 years of age and of sufficient age and capacity to participate in the Event and to sign an enforceable contract and/or a separate waiver and release form approved by INDYCAR.

**2.10.2.** INDYCAR may have additional or different eligibility requirements for a particular Event. INDYCAR reserves the right to limit participation to an age greater than 18 or to require additional documentation as a prerequisite to participation.

**2.10.3.** No one under age 18 shall be permitted in pit lane during any Events unless permitted by applicable insurance requirements and previously approved in writing by INDYCAR and/or the Event Promoter.

## **2.11. Moral Fitness**

**2.11.1.** The past or current conduct of an applicant or Member can have adverse consequences to INDYCAR.

**2.11.2.** An applicant or Member must honestly answer questions raised by INDYCAR as to moral character.

**2.11.3.** Applicants and Members agree INDYCAR may refuse a membership application or revoke a membership for any reason including, without limitation, those related to personal conduct, decency and whether or not any conduct of the applicant or Member creates adverse notoriety with respect to INDYCAR, the IndyCar Series, or an Event.

## **2.12. Physical and Psychological Fitness**

**2.12.1.** INDYCAR may require any applicant or Member to complete a medical history form and/or complete and pass a medical examination which may include drug testing consistent with the provisions of the Substance Abuse Policy. as directed by INDYCAR to determine physical and psychological fitness to receive a membership or License and/or to participate or continue in an Event. At any time, INDYCAR may require a Member to be examined and/or tested by a designated medical professional at the Member's cost.

**2.12.2.** Members must not use or be under the influence of illegal or prohibited drugs at any time, alcohol during an Event, and certain prescriptions and over-the-counter medications during an Event. Designated Competitors and Officials must complete and return to INDYCAR the current Substance Abuse Policy Authorization for Testing and Release and must comply with the provisions of the Substance Abuse Policy at all times. Whether or not an applicant or Member has formally executed the Substance Abuse Policy Authorization for Testing and Release, each applicant and Member agrees to submit to drug testing in accordance with the Substance Abuse Policy, which may include without limitation the collection of urine, blood, saliva, hair, breath and/or any other scientifically-acceptable method of analysis for prohibited substances and/or alcohol if requested by INDYCAR. Examination/testing may be for any drug, medication or other substance including without limitation alcohol. Applicants and Members shall be required to regularly review the Substance Abuse Policy and will be notified by INDYCAR as changes to the Substance Abuse Policy are made. Changes to the Substance Abuse Policy will apply as they become effective, and it is not an acceptable excuse for an applicant or Member to claim that they were unaware of a change to the Substance Abuse Policy or that such a

change is not reflected in the Rules for purposes of avoiding the consequences of noncompliance.

**2.12.3.** Any applicant or Member who is required to complete a medical history form and/or complete and pass a medical examination/test shall also immediately notify in writing i) the INDYCAR Medical Director if the Member becomes aware of a change in the Member's medical condition, including if the Member is diagnosed with any medical condition (including pregnancy) by any medical professional, and ii) to submit proof of any prescription the Member is required to take to the INDYCAR Medical Review Officer (and receive the INDYCAR Medical Review Officer's approval of such use prior to taking the substance in connection with any Event) (whether or not prescription drugs or medication and regardless of how taken).

**2.12.4.** INDYCAR may disqualify, suspend or otherwise penalize any applicant or Member for failure to promptly cooperate with any request for examination/testing and/or notification by INDYCAR and for any pending violation of the Substance Abuse Policy.

## **2.13. Medical Examinations and Treatment**

**2.13.1.** Examinations and/or treatment of Members, including emergency rescue, performed by medical professionals acting on behalf of INDYCAR are based upon a relationship established in the State of Indiana.

**2.13.2.** Members acknowledge that the medical professionals are acting pursuant to their contractual obligations with INDYCAR and are not acting or rendering personal medical services to the Members. Members acknowledge that they shall have their own personal physicians.

## **2.14. Determination of Fitness**

**2.14.1.** Members acknowledge that while the INDYCAR medical professionals render an opinion as to fitness, the final determination of a Member's ability to participate is made by INDYCAR in good faith.

## **2.15. Waiver of Claims**

**2.15.1.** Each applicant and Member waives any and all claims regarding any medical examinations/testing and/or examination/testing results, and/or the use or disclosure of such examinations/testing and/or examination/testing results, by INDYCAR, its agents and/or its medical professionals including without limitation claims of invasion of privacy and/or breach of confidentiality, notwithstanding whether such claims arise from strict liability, sole or contributory negligence of INDYCAR, its agents and/or its medical professionals, breach of contract, or any other legal or equitable theory.

## **2.16. Penalties**

**2.16.1.** INDYCAR may disqualify, suspend or otherwise penalize any applicant or Member if the results of any examination/test are determined by INDYCAR, its agents and/or its medical professionals to be a violation of the INDYCAR Substance Abuse Policy or to enhance, impair, or otherwise affect the Member's ability to be involved in and/or participate in any Event regardless of whether the applicant or Member's B sample, if applicable, has confirmed the A sample finding, in the case of a drug test. INDYCAR in its discretion may suspend or otherwise penalize any applicant or Member while such applicant or Member's matter, whether it is a positive drug test or other violation of the Substance Abuse Policy or other applicable Rule is pending or while

INDYCAR investigates the applicant or Member's potential Rule violation.

**2.16.2.** Any Member who shows visible signs of exhaustion, physical or psychological impairment, or other physical or psychological irregularities may be disqualified and/or excluded from an Event and subjected to additional examinations/tests and/or penalties.

## **2.17. Violation of Laws**

**2.17.1.** Being charged with a violation of the law, whether alcohol/substance abuse or any other laws, may be grounds for suspension or other penalty. Any Member charged with any violation of the law relating to alcoholic beverages or illegal substances, or charged with any felony, must notify the President of Competition and Operations prior to the next scheduled Event or within 72 hours of being so charged, whichever is earlier.

## **2.18. Medical Records**

**2.18.1.** Each applicant and Member agrees and consents that, where requested by INDYCAR for purposes of carrying out its due diligence and obligations under the Rules and the Substance Abuse Policy, he or she will not unreasonably deny INDYCAR access to and copies of any and all medical records of the Member where access to such information may be necessary in order for INDYCAR to make a determination with respect to the applicant or Member's eligibility for participation in an Event. Applicants and Members acknowledge that denial of access by INDYCAR to such information may delay or prohibit INDYCAR from permitting the applicant or Member to compete and/or participate in Events.



## **2.19. Memberships, Licenses and Credentials**

**2.19.1.** Prior to gaining access to restricted areas, each individual must have the necessary and appropriate credential. The holder of a membership, License or other credential shall produce it for inspection upon demand of INDYCAR or security personnel at any Event along with any other document needed to confirm identification.

**2.19.2.** The annual credential consists of both the lanyard and the hard card. Use of one without the other invalidates the annual credential. In addition, a Member must not use a prior Event's, prior season's or other series' credential.

**2.19.3.** A membership, License or any other credential (including race mode) may not be disassembled, transferred, assigned, sold, made subject to a lien, altered, or duplicated. It must be used only by the Member to whom it is issued. If a Member intentionally or unintentionally disassembles, transfers, assigns, sells, makes subject to a lien, alters, duplicates or otherwise permits another individual or entity to use or attempt to use the membership, License or credential, then the Member may be penalized and shall indemnify and hold INDYCAR Group harmless from any loss or expense incurred by INDYCAR Group arising in any way from the Member's action, even if the Member or a third party asserts that INDYCAR Group's loss or expense is due to INDYCAR Group's negligence.

**2.19.4.** The Rules regarding memberships, Licenses, and credentials are equally applicable to parking passes, Event credentials, golf cart passes, and all other privileges issued to a Member by INDYCAR or an Event Promoter unless such credentials, passes or privileges are expressly transferable, assignable, or eligible for sale.

**2.19.5.** INDYCAR may require an applicant and/or Member to provide a valid official government-issued identification including photograph and date of birth in order to receive or retain a credential. Acceptable identification includes without limitation a state Driver's licenses, passports and military cards but does not include identification issued by educational institutions or any nongovernmental entity.

**2.19.6.** Members are responsible for the conduct of their Participants and guests.

## **3. SANCTIONS**

### **3.1. Promotion of Races**

**3.1.1.** INDYCAR will sanction Races with an Event Promoter through an Event Agreement. The Event Agreement contains additional terms regarding the Race, such as those relating to postponement dates.

### **3.2. Event Promoter Responsibilities**

**3.2.1.** Event Promoters shall be responsible for designated operations including without limitation responsibility for obtaining and providing, at the Event Promoter's expense, insurance as required by the Event Agreement, safety precautions, services and vehicles for Competitors and spectators including medical/rescue personnel, equipment, transportation and facilities (such as ambulances, air medical helicopters and examination facilities and equipment); physical condition of the Track; spectator control; and fire protection, all to meet or exceed the minimum requirements provided by INDYCAR and where applicable, the ASN.

**3.2.2.** INDYCAR shall not be responsible or in any manner liable for any of the Event Promoter's responsibilities under the Event Agreement or the Rules even if the Event Promoter fails or refuses to perform such functions, duties and responsibilities, in whole or in part, or if INDYCAR voluntarily assumes performance of any or all of the Event Promoter's specific functions, duties and responsibilities.

**3.2.3.** Entrant acknowledges that the Event Promoter has reserved and has the right to place additional regulations into effect if, in the discretion of INDYCAR and/or an Event Promoter, such additional regulations become desirable. In the case of a conflict in the Rules, INDYCAR shall make a determination and its interpretation and determination shall be final.

### **3.3. Restrictions**

**3.3.1.** Event Promoter shall not schedule any ancillary or supporting entertainment, events, or activities that include racing activity on the Track during the Event without prior written approval by INDYCAR, in each instance.

## **4. ENTRANTS/DRIVER REGULATIONS**

### **4.1. General**

**4.1.1.** Licensing criteria are available from the INDYCAR office and may vary depending on the particular on Track activity. Entrants and Drivers must remain in good standing to participate in an Event. All License applications shall be made on forms by INDYCAR and submitted to INDYCAR. INDYCAR and ACCUS-FIA (and another ASN, if applicable) shall determine whether to approve and issue a License application. Applicant shall pay any and all costs associated with satisfying the License criteria. Driver Licenses are not transferable at any time; Entrant Licenses are not transferable without prior written approval.

**4.1.2.** Unless otherwise approved by INDYCAR, Entrant must possess an INDYCAR annual membership, an INDYCAR Entrant's License, and an ACCUS-FIA Entrant's License (including international competition privileges), and Entrant must remain in good standing at all times during the on-Track Event.

**4.1.3.** Unless otherwise approved by INDYCAR, Driver must possess an INDYCAR annual membership, an INDYCAR Driver's License, and an ACCUS-FIA Driver's License (including international competition privileges) or another ASN Driver's License, if applicable, and the Driver must remain in good standing at all times during the on-Track Event.

**4.1.4.** Licenses are revocable by INDYCAR and ACCUS-FIA at any time and for any reason. Without limiting the

foregoing, Licenses for Rookie Drivers are granted on a temporary basis.

**4.1.5.** Licenses may be limited to a particular type of Event(s) or for a specified period.

**4.1.6.** Licensed Entrants and Drivers are eligible to earn awards and points as described in the Rules.

**4.1.7.** Eligibility for a License shall be determined based on such factors as are indicative of the applicant's ability to participate satisfactorily in an Event.

**4.1.8.** Fees may be charged for Licenses.

**4.1.8.1.** Fees are non-refundable whether or not the License is granted. No fee or any part thereof shall be refunded to a licensee because the licensee ceases to participate in any Event(s) regardless of the reason for such cessation.

**4.1.8.2.** License fees are for an entire season and will not be pro-rated for any reason including, without limitation, for Members who begin participating after the first Event or who stop participating prior to the completion of all Events.

**4.1.9.** A License is valid only for the current season and/or as otherwise restricted. Unless otherwise noted, all Licenses shall expire on December 31 of the calendar year during which they were granted.

**4.1.10.** An applicant may protest and/or appeal denial of a Driver or Entrant License and membership application, grade of Driver's License, determination of Rookie status or eligibility for a Rookie orientation or refresher Test in accordance with the procedures set forth in Rules 12 and 13.

**4.1.11.** INDYCAR may continuously re-evaluate the eligibility and performance of a Driver and/or Entrant to determine if the Driver and/or Entrant shall remain licensed. As part of such evaluation, INDYCAR may consider input from any Official, any Driver and others as INDYCAR determines appropriate and may require a Driver and/or Entrant to participate in Testing under the observation of Officials, Drivers, and/or others.

## **4.2. Entrant License**

**4.2.1.** The individual signing the application represents that the individual is authorized to act on behalf of the named Entrant in all matters. Additional corporate representatives may be listed, and the authority of any individual may be limited. One corporate representative must be present at each Open Test and Races.

**4.2.1.1.** If a corporate representative's status changes, INDYCAR may require an individual authorized to act on behalf of the Entrant submit a new application for that Entrant for approval. INDYCAR may require an Entrant to submit another Entrant License fee and resubmit any other materials including, without limitation, a Leaders Circle Program Agreement, Entry forms, or any other requirements as determined by INDYCAR etc.

**4.2.1.2.** Upon request, INDYCAR must be provided satisfactory information regarding ownership of an Entrant.

## **4.2.2. Eligibility**

**4.2.2.1.** After receipt of the application, the Entrant's competitive and business viability will be assessed to determine whether to approve and issue the license.

Factors taken into account may include, without limitation:

**4.2.2.1.1.** Purchase and/or lease agreements with Manufacturers;

**4.2.2.1.2.** Purchase and/or lease agreement for its shop; and

**4.2.2.1.3.** Employment or consultancy agreements with key personnel including, without limitation, team manager, engineer, chief mechanic, and Driver.

**4.2.3. Entry** - Upon issuance of the Entrant License, the Entrant may submit a Leaders Circle Program Agreement and Entry forms identified by the Car number assigned to that Entrant License. The Entry (Car with Driver) must display the Car number at all times during the Event, and all points and awards earned by this Entry will be credited to that Car number unless otherwise determined by INDYCAR. An Entrant intending to compete with multiple Entries at a single Event must obtain an Entrant License with a unique Car number for each Entry or satisfy such other requirements as INDYCAR may prescribe.

**4.2.3.1.** The Entry shall automatically include a primary and backup Car unless indicated otherwise. The first Car presented at technical inspection shall be the primary Car. The second Car presented at technical inspection shall be the backup Car.

**4.2.3.2. Indianapolis 500® Mile Race:** If Entrant wins the Indianapolis 500® Mile Race, it agrees to grant to the Event Promoter or its designee, through execution of a separate agreement, the right to possess and use the winning Car for display during



mutually-agreed upon times. Consideration for the above use of the winning car is acknowledged as the opportunity to compete for awards for the on-Track Event and acceptance of the Entry.

#### **4.2.4. Chief Mechanic**

**4.2.4.1.** Each Entry must have a chief mechanic.

**4.2.4.2.** The chief mechanic is responsible for the Car complying with the Rules.

**4.2.4.3.** The chief mechanic must be in the Car's assigned pit when the Car is on the Track and must accompany the Car during all technical inspection processes.

**4.2.4.4.** Entrant agrees its chief mechanic shall serve as an authorized corporate representative regarding all issues related to technical inspection.

**4.2.4.5.** An Entrant shall replace its chief mechanic if INDYCAR determines that the chief mechanic is not sufficiently qualified.

**4.2.5. Spotters** - At all Oval Races and Oval Tests whenever more than one Car is on Track, a spotter is required for each Entry. They must be in the designated location(s) and have a radio capable of communicating with the Driver and an individual in the Entrant's pit. Track specific spotter requirements will be confirmed by Bulletin.

**4.2.5.1.** Spotter Registration – A Entrant may register up to six (6) spotters. Spotters are subject to INDYCAR approval.

**4.2.6. Manufacturers** – The Manufacturers may require an Entrant to enter into lease and/or purchase agreements.

### **4.3. Driver License**

**4.3.1.** Licenses may be approved and issued to individuals determined eligible by INDYCAR to compete in an Event and who otherwise meet the application requirements.

**4.3.2.** The determination of whether the applicant may take a Driver's Test and whether the applicant successfully completed the Test shall be made by INDYCAR.

**4.3.3.** INDYCAR and/or ACCUS-FIA (and another ASN, if applicable) shall determine the grade of the License issued to a Driver.

**4.3.4.** In order for a Driver to compete in any Event, the Driver must hold a Driver License and at any time may be required to:

- a)** Participate in any INDYCAR required Testing;
- b)** Provide an updated resume, and/or certified birth certificate;
- c)** Furnish a current clearance acceptable to INDYCAR attesting to the Driver's physical/psychological fitness for racing;
- d)** Provide proof of United States residency and an international letter of authorization from the Driver's home country ASN, in the case of Drivers who are not citizens of the United States.

### **4.3.5. Eligibility**

**4.3.5.1.** An applicant must have sufficient competitive driving ability and experience as determined by INDYCAR.

**4.3.5.2.** INDYCAR's determination as to ability will take into account all such factors as INDYCAR deems relevant. The criteria taken into account by INDYCAR are listed below. The criteria are subject to change at any time. An applicant must contact INDYCAR for the current Race-specific criteria.

**4.3.5.3.** INDYCAR may require the applicant to provide:

**4.3.5.3.1.** A current resume containing a complete history of the applicant's competition to date and demonstrating the applicant's ability to properly and safely handle the Car;

**4.3.5.3.2.** A letter of recommendation from the the series in which the Driver last competed; and/or

**4.3.5.3.3.** Such other information as INDYCAR may request.

**4.3.6. Physical/Psychological Information** - The applicant must provide the information required by INDYCAR and must successfully complete any INDYCAR-prescribed physical and psychological examinations, which may include, without limitation, eye, neurological and substance abuse testing.

### **4.3.7. Rookie General**

**4.3.7.1.** If a Driver begins the season as a Rookie, he/she remains a Rookie until the end of that season.

**4.3.7.2. Rookie Orientation Test** – An applicant must demonstrate Car control, placement, and a consistent driving pattern. INDYCAR may require additional Testing including, without limitation, Testing in close proximity to other Cars, before an applicant may be permitted to participate in an Open Test and/or Race.

**4.3.7.3. Refresher Tests** - An applicant, including, without limitation, a Driver who has not participated as a Driver in any Event during the past twelve (12) months, may be required to successfully complete a refresher Test. In lieu of a refresher Test, INDYCAR may require an applicant to successfully complete a Rookie orientation Test.

**4.3.7.4. Costs** – An applicant shall pay all costs incurred by INDYCAR relating to any Tests approved by INDYCAR.

### **4.3.8. Indianapolis 500® Mile Race Eligibility**

**4.3.8.1. Rookie Orientation Test** - Successful completion of a Rookie orientation Test at another Race Location and/or participation in an Event does not satisfy this requirement.

**4.3.8.2.** INDYCAR shall hold a mandatory Driver and team manager meeting prior to the beginning of the Rookie orientation Test session. At this meeting, INDYCAR will announce the speed phases and other requirements for the Rookie orientation Test.

**4.3.8.3.** In addition to Car control, placement and a consistent driving pattern, the Rookie orientation Test shall consist of three phases, totaling 40 laps: Phase One 10 laps at 200-205mph, Phase Two 15 laps at 205-210mph and Phase Three 15 laps at 210+mph. The laps do not have to be consecutive. The phases and corresponding speeds may be adjusted based on Track/weather conditions.

**4.3.8.4.** Rookie Drivers must successfully complete a minimum of two of the three phases to be eligible to participate in practice when practice for the Event begins. No Rookie Driver will be eligible for a qualifications attempt prior to completing the final phase.

**4.3.8.5.** Veteran Drivers shall be posted around the Race Location to observe Track activities. Drivers will be permitted time to practice after the completion of one phase and before beginning the next phase.

**4.3.8.6. Refresher Test** – If a Driver has not participated in the IndyCar Series since the prior year's Indianapolis 500® Mile Race, INDYCAR will determine if any additional Testing shall be required. In addition to Car control, placement, and a consistent driving pattern, the refresher Test consists of the 25 laps that make up the second and third phases of the Rookie orientation Test. No such Driver will be eligible for a qualifications attempt prior to completing the refresher Test.

**4.3.8.7. Rookie Orientation** - Except as otherwise approved by INDYCAR, Rookie orientation Tests shall only be conducted during the designated times/dates designated by INDYCAR.

## **4.4. Communication**

**4.4.1.** All Members agree INDYCAR owns all rights to voice, data and telemetry collected by or on behalf of INDYCAR including without limitation all voice, data and telemetry from radio and wireless data frequencies.

### **4.4.2. Radio & Radio location**

**4.4.2.1.** The in-Car radio must be analog only and must not be capable of transmitting or receiving in a digitized, encrypted, scrambled format or otherwise affect INDYCAR'S ability to record, scan, and hear at any time during the Event. Channel hopping transmissions to or from the in-Car radio are not permitted. All voice radio transmissions to or from the Car must be in the 450.000 MHz to 470.000 MHz range.

**4.4.2.2.** Radios may not be located in the cockpit area.

**4.4.3. Radio Frequencies** – Each Member transmitting or receiving any signal including, without limitation, voice, data, and telemetry, but excluding Internet related Wi-Fi (regulated pursuant to Rule 4.4.4) shall:

**4.4.3.1.** Provide the specifications (e.g., manufacturer, make, model, and serial number) of the radio to be used in the Car to the INDYCAR-designated representative prior to the Entrant's first Race;

**4.4.3.2.** Not password-protect or otherwise affect or limit the INDYCAR-designated representative's ability to scan and hear the radio to be used in the Car at any time;

**4.4.3.3.** Notify the INDYCAR-designated representative immediately upon changing any of the specifications of the radio to be used in the Car;

**4.4.3.4.** Consent, and hereby does consent, to the taping and/or rebroadcast by INDYCAR or its designee of any such transmissions through any and all media and for any and all purposes; and

**4.4.3.5.** Comply with all applicable laws regarding such use, and indemnify and hold INDYCAR Group harmless with respect to failure to comply with applicable laws, even if the violation involves INDYCAR Group's or its designee's sole or contributory negligence.

**4.4.4. Wireless Data Frequency ("Wi-Fi")** - Each Member transmitting or receiving any signals for wireless data transmissions shall upon request:

**4.4.4.1.** Register the frequency and sub-level channels with the INDYCAR-designated representative at each Event according to the following schedule:

**Non Indianapolis 500® Mile Race Events:** a minimum of 24 hours prior to Cars on the Track at each Event, and

**Indianapolis 500® Mile Race:** by the designated time/date.

**4.4.4.2.** Notify the INDYCAR-designated representative immediately upon changing frequencies or sub-level channels;

**4.4.4.3.** Coordinate and modify frequencies for use with other wireless data networks as specified by INDYCAR; and

**4.4.4.4.** Comply with all applicable laws regarding such use, and indemnify and hold INDYCAR Group harmless with respect to failure to comply with applicable laws, even if the violation involves INDYCAR Group's sole or contributory negligence.

**4.4.5. Radio Communication** - During all Track Events, radio communication between the Driver and the Entrant's pit is required at all times. At INDYCAR's Discretion, a Car may be black flagged and ordered to repair the radio.

**4.4.5.1.** Car to Car radio communication is not permitted.

## **4.5. Car Registration**

**4.5.1. Car Names** - A Car must have a name that shall be identified on the Entry form. The Entrant represents to INDYCAR that it has the right to use that Car name. The Car name is subject to the approval of INDYCAR and must not exceed 35 characters, including all spaces and punctuation.

**4.5.2.** A Car may compete only in the Events in which the Car is entered. The Entry form must establish the Entrant's right to enter the Car in the Event and include proof of ownership of the Car acceptable to INDYCAR. INDYCAR will use registration and Car numbers to identify the Car.

**4.5.3. Registration Number (serial number)** – The unique number assigned by Dallara.



**4.5.4. Car Number** – INDYCAR will assign to each Entrant License (not Driver License) a unique Car number. The Car number may consist of a maximum of two digits. No Car number may begin with the 0 digit. Car number 1 will be reserved for the defending Entrant (not Driver) series champion.

**4.5.4.1.** All Car numbers are owned by INDYCAR. No Member has a right to or ownership interest in a Car number.

**4.5.4.2.** INDYCAR shall determine the assignment, or reassignment, of Car numbers. Such decisions may not be protested and/or appealed. All Entrants desiring a particular Car number must make a written request to INDYCAR. INDYCAR will not guarantee a request will be granted.

**4.5.4.3.** After a Car number is assigned to a particular Entrant License, it will remain with that Entrant License until the end of the current season, provided that Entrant enters a Car and displays the Car number on the Car at each Event. If the Entrant does not enter a Car and/or display the Car number on the Car at an Event, INDYCAR may reassign the Car number.

**4.5.4.4.** The required Car number locations must be clearly visible as determined by INDYCAR. The required number must be in Impact font, black or white in color, positioned on a solid single colored background and maintain a 2.00 inch area around the numbers, free of all other decals, trim, color, advertisement and decorations. Trim color around the number is permitted unless otherwise specified, provided it does not distort the number font. All aspects of the Car number including, without

limitation, height, and width must be approved by INDYCAR prior to use.

**4.5.4.4.1.** Indianapolis 500® Mile Race - "T" numbers are assigned to an Entrant's second (or Backup) Car incorporating the Car number of the first (or base) Car. Any Car which displays a "Backup" Car number must display the single letter "T" in a five (5) inch minimum height adjacent to and behind the Car number in all required number locations. The "T" must be displayed throughout all practice sessions and/or qualifying unless otherwise approved by Officials.

**4.5.4.5. Left and Right Rear End Fences and Nose** – The minimum height of the numeric digit must be nine (9) inches. A portion of the Car number on the nose must be located on the front shock cover. **(See illustration)**

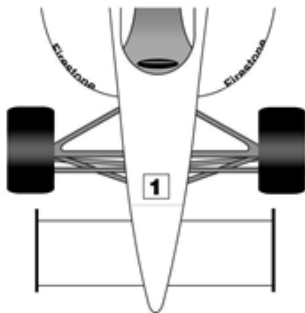

**4.5.4.6. Headrest** - The Car number must be a minimum dimension of 1 inch by 1 inch. The Car number must be located on top of the headrest behind the Driver's helmet. Letters and numbers must be in Impact font, black or white in color, and no trim is permitted. **(See Illustration).**



**4.5.4.7. Tub** - The Car number and Driver's first and last name must be 1 inch tall each. Letters and numbers must be in Impact font, black or white in color, and no trim is permitted. This must be located directly behind the headrest. **(See Illustration).**



**4.5.4.8. Speedway Rear Wheel Pods** - The Car number located inside of the wheel pods in the INDYCAR-approved location must be a minimum of six (6) inches in height. Letters and numbers must be in Impact font, white in color, and no trim is permitted. **(See Illustration).**

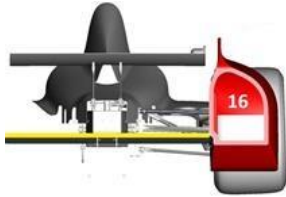

**4.5.4.8.1.** The Car number located on the side of the wheel pods must have a minimum height of the numeric digit must be nine (9) inches and the top of the numeric digit must be six (6) inches from the top of the rear wheel pod. Numbers must be in Impact font, black or white in color with a minimum clearance of two (2) inches around the number and approved by INDYCAR. **(See Illustration).**

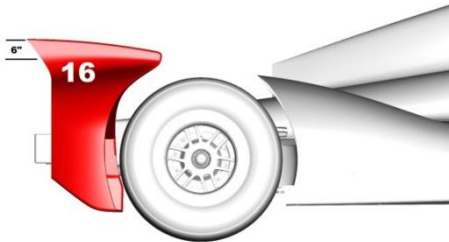

**4.5.4.9. Car Appearance** – INDYCAR has the right to control the appearance of Cars to distinguish one Car from another. This may include, without limitation Car color. Cars are required to display significantly different colors. In general, INDYCAR may require different color schemes on any four of the following seven parts:

- a) Mirror housing
- b) Air intake
- c) Roll hoop camera cover
- d) Front and rear wing end fences
- e) Leading edge of the front wing
- f) Leading edge of the rear wing
- g) Attenuator

**4.5.4.9.1. Rookie Designation** - Rookies must run a fluorescent yellow stripe on the beam wing rear edge at all Events, and a fluorescent yellow number in the wheel pod for all Speedways. (**See illustration**).



## **5. ENTRIES**

### **5.1. General**

**5.1.1.** All Entry applications shall be completed on forms provided by INDYCAR in the form required by INDYCAR and shall be subject to the approval of INDYCAR. Entries are not transferable without the prior written approval of INDYCAR.

**5.1.2.** An Entry consists of an Entrant, Driver, numbered Car and named Car. At designated Events, an Entry may include a Backup Car with a backup "T" number.

#### **5.1.2.1. Entrant**

**5.1.2.1.1.** An approved Entry serves as the authorization to compete in a specific Event or Events(s) on behalf of the specific Entrant to whom the Car number is assigned and acknowledgement of and agreement to the Rules.

**5.1.2.1.2.** If an Entrant participates in any Event without having properly submitted a fully executed Entry form, the Entrant, by such participation, nevertheless agrees that the Entrant is subject to all Rules, and all statements, releases and obligations appearing in the Entry form for the Event, as if the Entrant had properly submitted a fully executed Entry form.

**5.1.2.1.3.** In recognition of the support of racing fans and efforts and monies expended by sponsors, INDYCAR and Event Promoter in connection with the Events, Entrant, on behalf of Entrant Group, agrees to participate in on-Track Events in which Entrant has submitted, and INDYCAR has approved, an Entry. Entrant agrees not to engage alone or with others in tactics which would disrupt or delay the on-Track Events and to cooperate fully with ceremonies preceding, during, and following the on-Track Event and to refrain from any conduct which would disrupt or detract from such ceremonies.

**5.1.2.1.4.** Entrant understands and agrees that INDYCAR has the right at any time to withdraw the privileges of participation or otherwise reject, exclude or disqualify any member of Entrant Group, including but not limited to any Car, driver or other Entrant Participant, if INDYCAR in its discretion determines that rejection, exclusion or disqualification is in the best interest or integrity of INDYCAR, the IndyCar Series or the promotion of Events. Entrant, Driver and any third party they represent, including without limitation other Entrant Participants, shall have no claim for damages or injunctive relief against INDYCAR, any Event Promoter and/or their representatives by reason of such rejection, exclusion or disqualification.

**5.1.2.1.5.** Entrant shall receive a designated number of annual credentials, Event only credentials, race mode credentials, and passenger car parking passes for each Event as determined by INDYCAR.

### **5.1.2.2. Driver**

**5.1.2.2.1.** Each Entry form must list a Driver.

**5.1.2.2.2.** Another Driver may be substituted for the original Driver, provided notification is given to INDYCAR, and INDYCAR approves the substitution.

### **5.1.2.3. Car**

#### **5.1.2.3.1. Participation of a Car in an Event -**

In order to participate in an Event, the Car must be properly entered and be designated and explicitly identified by Car number on only one Entry form for that Event. Notwithstanding any prior INDYCAR approval, any Car participating in an Event while in noncompliance with the above requirements may be disqualified, and any Competitor who causes such noncompliance may be disqualified and/or otherwise penalized by INDYCAR.

#### **5.1.2.3.2. Car Substitution during an Event (“Backup Cars”)**

**5.1.2.3.2.1.** An Entrant’s Backup Car must remain on the transporter without an Engine installed. The Backup Car may only be removed, have an Engine installed and used in any on Track activities during the Event with prior approval by INDYCAR.

**5.1.2.3.2.2.** An Entrant is permitted to remove its Backup Car from its transporter and install an Engine, provided the Entrant is scheduled to participate in another



INDYCAR-approved activity within the next 7 days.

**5.1.2.3.2.3.** For international Events, INDYCAR may require engines be installed in all Backup Cars as determined by space availability.

## **5.2. Fees**

**5.2.1.** Entry fees must be paid in good funds as directed by INDYCAR.

## **5.3. Deadline**

**5.3.1.** The Entry deadline shall be stated on the Entry form. Unless otherwise specified on the Entry form, the hour of closing shall be 5pm E.D.T. on the day of the Entry deadline. INDYCAR may accept or refuse to accept late Entries. Late Entrants, if accepted, may be penalized by INDYCAR.

## **5.4. Electronic Entries**

**5.4.1.** An Entry by computer, facsimile or other means delivered by the closing of the Entry deadline may be accepted, provided it is subsequently accompanied by the original completed Entry form and Entry fee within 48 hours of INDYCAR's receipt of the electronic Entry or as otherwise directed by INDYCAR.

## **5.5. Reopening of Entries**

**5.5.1.** If INDYCAR postpones an Event, INDYCAR may authorize the reopening of Entries. Reopened Entries shall close not less than forty-eight (48) hours before the declared starting time of the postponed Event.

## **5.6. Failure to Participate**

**5.6.1.** Any Driver, Entrant, or other Member who by Entry form or other means has agreed to participate in an Event may be penalized for failing to participate.

## **5.7. Entry Change**

**5.7.1.** All changes to an approved Entry form shall be completed on INDYCAR provided forms and subject to approval by INDYCAR prior to the Entrant's Car participating in any on Track activities. Notwithstanding the foregoing, a substitute Driver must be approved pursuant to Rule 5.1.2.2.2.

## **5.8. Points and Awards**

**5.8.1.** Entrants and Drivers displaying the mandatory award sponsors and otherwise complying with the Rules may be eligible to earn points and awards.

**5.8.2.** All awards may be withheld by INDYCAR in whole or in part, or denied in whole or in part, if INDYCAR determines in its discretion that any member of Entrant Group has failed in any way to comply with the terms and conditions of the Rules.

## 6. TESTING

### 6.1. General

**6.1.1.** Members are only permitted to conduct Testing in accordance with these Rules.

**6.1.2.** These Rules apply from October 20, 2013 through the last Race of the 2014 season.

**6.1.3.** Testing requests must be submitted via IRIS to INDYCAR for prior approval, with the exception of rig Testing which must be reported to INDYCAR. The request is required a minimum of twenty-one (21) Days prior to any on track activity. Full size wind tunnel Tests require a 7-Day notice period and complete Car rig Tests must be reported to INDYCAR within 7 Days of the Test. If a test is approved, INDYCAR may establish conditions for approval including without limitation requiring the presence of an Official. Cancellations must be sent to INDYCAR a minimum of seventy- two (72) hours prior to the Test to avoid charges.

**6.1.4.** Violations of the Testing Rules shall result in penalty including without limitation the loss of up to 50 Entrant, Driver, and/or Engine Manufacturer points and a monetary fine not to exceed \$500,000.

**6.1.5.** Any combination of Drivers may participate in a Test. The Driver is not required to be the Entrant's current Driver. The Driver must hold a current IndyCar Series Driver's License/Membership and be in good standing with INDYCAR.

**6.1.6. Mileage** – Full-Season Entrants are allocated a maximum of ten thousand (10,000) total miles for use in all Team Tests, Open Tests, and Race Events from the end of the 2013 Race season to the end of the 2014 Race season. Each Entrant must manage its miles accordingly to avoid penalties.

**6.1.7. Tires** – An Entrant must select quantity from their total allotment of Tires subject to availability.

## **6.2. Approved Testing**

**6.2.1.** A Team is permitted a total of eighteen (18) Testing Days, made up of the following: Engine Manufacturer Tests, Team Tests, Open Tests, and Full Size Wind Tunnel Tests.

**6.2.2. Engine Manufacturer Test** – An Engine Manufacturer Test is a Test organized by an Engine Manufacturer to which selected Entrants are invited to participate. An Engine Manufacturer must permit other Engine Manufacturers to participate, provided such Engine Manufacturers are in good standing with INDYCAR (up to the maximum number permitted by the facility). Mileage accrued while using a Manufacturer development Engine will not be counted against an Entrant's 10,000 mileage allocation.

**6.2.3. Team Test** – A Team Test is a Test organized by an Entrant. An Entrant must permit other Entrants to participate, provided such Entrants are in good standing with INDYCAR (up to the maximum number permitted by the facility).

**6.2.4. Open Test** – Includes without limitation the following:

- a)** March 17-18, Barber (Spring Training)

**b)** April 30, Indianapolis Motor Speedway Road Course.

**c)** August 27, Fontana

**6.2.4.1.** Other than Spring Training, which is mandatory for Leaders Circle Entrants, Entrants must commit their attendance at Open Tests prior to the first Event of 2014. Failure to attend after committing to an Open Test will incur a cancellation fee of \$5,000 and loss of one Test Day. Non-Leader Circle Entrants will be subject to a Test fee of \$2,500. Late Test requests will be subject to an additional \$2,500.

**6.2.5. Full Size Wind Tunnel Tests** – Full Size Wind Tunnel Tests are restricted to a maximum of 12 hours within any 24-hour period.

**6.2.6. Rookie & Refresher Tests** – In addition to the Test Days provided in Rule 6.2.1, Entrants are allocated two (2) additional Team Test Days for the purpose of Testing a Rookie Driver. Additional days may be approved by INDYCAR.

**6.2.6.1.** All Rookies must complete a Super Speedway Rookie Test prior to competing in a Super Speedway Open Test or Race Event. An INDYCAR Official must be present at this Test. This will not count against an Entrants Test Day or Rookie Test Day allocation.

**6.2.6.2.** All Rookies participating at only the Indianapolis 500® Mile Race will be allocated a one Day Super Speedway Test prior to the Event.

**6.2.7. Indy Lights Driver Test** – In addition to the Test Days provided in Rules 6.2.1, and Rule 6.2.6, Entrants

are allocated two (2) additional Team Test Days for the purpose of Testing a current Indy Lights Driver.

**6.2.8. New Entrant Test** – In addition to the Test Days provided in Rules 6.2.1, 6.2.6, and 6.2.7, new Entrants are allocated four (4) additional Team Test Days for the purpose of Testing during the Off-Season in total.

**6.2.9. Media/TV/Photo-Days** – Entrants requiring a running Car for the purposes of promotion, sponsor commercial, or special marketing needs etc., may be granted additional Test Day(s), subject to INDYCAR approval.

### **6.3. INDYCAR-Approved Venues**

**6.3.1.** Tests must only occur at the following INDYCAR-approved venues:

**6.3.1.1.** All 2014 INDYCAR Series Race venues, except the Indianapolis Motor Speedway Oval and street course venues.

#### **6.3.1.2. Road Courses**

- Circuit of The Americas - Austin
- Homestead Miami Speedway
- Indianapolis Motor Speedway Road Course
- Mazda Raceway Laguna Seca
- Palm Beach International Raceway
- Portland International Raceway
- Road America
- Sebring International Raceway
- Watkins Glen International

#### **6.3.1.3. Ovals**

- Chicagoland Speedway

- Homestead Miami Speedway
- Kansas Speedway
- Kentucky Speedway
- Michigan International Speedway
- Nashville Superspeedway
- New Hampshire Motor Speedway
- Phoenix International Raceway
- Richmond International Raceway

**6.3.1.4.** Straight line Testing at venues other than those approved by INDYCAR is not eligible for INDYCAR's standard participant accident insurance coverage.

## **6.4. Testing Periods**

**6.4.1.** Except for Open Tests provided in Rule 6.2.4, on-track Testing is not permitted within seven (7) Days prior to the start of on-Track activity at an Event Location (e.g., first practice Friday / Testing concludes end of the Day Thursday week prior). In addition, on-track Team Testing is not permitted on the following Days:

- a)** October 20, 2013 to November 4, 2013 (Post Season)
- b)** November 25, 2013 to December 2, 2013 (Thanksgiving)
- c)** December 21, 2013 to January 6, 2014 (Holiday)
- d)** January 13-15, 2014 (Indy Forum)
- e)** March 17-18, 2014 (Spring Training)
- f)** May 1-26, 2014 (Indy)

**g)** August 31 – September 15, 2014 (Post Season)

**6.4.1.1.** Blackout dates do not apply to wind tunnel and rig testing with the exception of Rule 6.4.1.a), c), and e).

## **6.5. Additional Testing Restrictions**

**6.5.1.** Members agree to provide a minimum of one hour of media availability per Day.

**6.5.2.** Mileage must only be used by the designated Entrant and must not be sold or assigned.

**6.5.3.** An INDYCAR-approved private test facilitator must be present at all Tests except as otherwise approved by INDYCAR. Entrant agrees to cooperate with any and all directives of the private test facilitator.

**6.5.4.** Model wind tunnel and rig testing is permitted.

**6.5.5.** Members shall not Test in simultaneous on-track activity with any non IndyCar Series vehicles (including without limitation Indy Lights cars).



## 7. AT TRACK PROCEDURES

### 7.1. On Track Conditions

**7.1.1.** INDYCAR determines the Track Condition. Track Conditions include the following:

**7.1.2. Green Condition** - The Green Condition signifies racing conditions.

**7.1.3. Yellow Condition** – The Yellow Condition signifies caution.

**7.1.3.1. Ovals** –All Drivers shall reduce speed immediately, maintain position, and yield to safety vehicles and/or personnel.

#### **7.1.3.2. Road/Street Courses**

**7.1.3.2.1. Local** – All Drivers shall reduce speed and be prepared to stop. Passing is not permitted between the first Yellow Condition and the subsequent Green Condition.

**7.1.3.2.2. Full Course Yellow All Events During a Race** - All Drivers are required to proceed with caution, observe the flags, maintain position, and yield to safety vehicles and personnel. Upon the commencement of a full course Yellow Condition, INDYCAR shall declare whether the pit lane shall remain open or closed. This declaration will be made during announcement of the commencement of the full

course Yellow Condition. The Safety Car will be dispatched and pick up the leader.

**7.1.3.2.3.** Drivers are required to form a single file line and pack up behind the Safety Car.

**7.1.3.2.4.** If the pit lane is declared to be open, all Cars may enter the pit lane at their Discretion.

**7.1.3.2.5.** If the pit lane is declared to be closed:

- a) The Race leader shall return to Safety Car speed.
- b) The pit lane shall remain closed until INDYCAR declares the pit lane open.
- c) Any Driver at or past the pit commit line prior to commencement of the Yellow Condition may make a pit stop and exit the pit lane with caution.
- d) Any Driver entering the pit lane following the commencement of a full course Yellow Condition before the pits are declared open may avoid penalty by proceeding through the pit lane without stopping.
- e) Only required work may be performed on the Car while the pits are closed. If required work is performed on the Car while the pits are closed, the Car must then return to its pit stall and come to a complete stop on the lap after the pits have been opened to all Cars. INDYCAR will penalize any Competitor who: i) performs work on its Car other than

required work or ii) does not make the additional required pit stop.

**7.1.3.2.6.** The pit lane will start and end at points designated by INDYCAR. The pit entrance and pit exit lanes are considered part of the Track. Drivers exiting the pit lane shall rejoin the pack relative to the position they are to the Safety Car and/or Cars on Track as they cross the blend out line. Taking improper position upon leaving the pit lane or failing to follow the direction of INDYCAR may result in a minimum one-lap penalty. The INDYCAR determination of the order is not subject to protest and/or appeal.

**7.1.3.2.7.** A Car must not use pit lane to improve its position relative to the Safety Car or any Car remaining on the Racing Surface, but a Car may improve its position relative to other Cars in pit lane.

**7.1.3.2.8.** Laps completed will be scored, unless stated otherwise.

**7.1.3.2.9.** INDYCAR shall determine if the leader or any other Car fails to pace the Race as directed. INDYCAR shall determine the type and timing of any penalty as it deems appropriate. Such decision is not subject to protest and/or appeal.

**7.1.4. Red Condition** - The Red Condition signifies termination of on-Track activities.

**7.1.4.1. Practice/Qualifying** - All Drivers are required to slow to caution speed, maintain position and yield to safety vehicles and personnel. Cars are

required to return to their pit location. Lap timing ceases at the declaration of a Red Condition.

**7.1.4.2. Race** - The Red Condition signifies racing conditions are no longer in effect.

- a) Competitors must proceed cautiously to a location designated by Officials.
- b) Unless otherwise instructed by INDYCAR, no work is permitted on the Cars, except Entrants may plug in a booster battery and apply towels to bodywork.

**7.1.5.** The decision as to whether to declare a Green, Yellow, Full Course Yellow, or Red Condition may not be protested and/or appealed.

**7.1.6.** While additional information regarding Track Condition is included in the Flag Code section for convenience, this information is equally applicable to the other systems of notification (Track lights, race control frequency, Track condition radio and instant messaging).

**7.1.7.** Decisions by INDYCAR are effective immediately, regardless of the time the declaration is received by the Competitors. INDYCAR uses multiple systems to notify Competitors of such decisions and will make a reasonable effort to declare Track condition changes at the time it is determined. All Competitors shall react to the first notification they receive. The systems include the following:

**7.1.7.1. Track Lights** – Green and/or yellow lights positioned around the Track above the outside retaining wall adjacent to the debris fence.

**7.1.7.2. Pit Lane Exit Light** - If another Car on-Track is approaching the pit lane exit, the pit exit lights will flash blue to warn Drivers leaving the pits.

**7.1.7.3. "Race Control Frequency"** – The radio frequency used by INDYCAR to provide direct communication to Entrants during Events. The spotter (if applicable) and a representative of the Entrant in the Entrant's pit must both monitor it. Entrants failing to monitor the Race Control Frequency shall be charged with knowledge of communication on such frequency and are subject to penalty. Competitors failing to follow directions may be penalized.

**7.1.7.4. Track Condition Radio ("TCR")** - All Cars must use the INDYCAR-supplied TCR and wiring harness without modification.

**7.1.7.4.1. Oval Events** - The TCR signals a Yellow Condition.

**7.1.7.4.2. Road/Street Course Event** - The TCR signals a Full Course Yellow during a Race or Red Condition during, practice or qualifying sessions.

**7.1.7.5. Instant Messaging** - Race Control will send messages where applicable to the Entrant(s). This system may be used to communicate Track conditions, send warnings, penalties, or other information to the Entrant. The system may send information to an individual Entrant or to the entire field.

**7.1.7.5.1. Instant Messaging Protocol** – In addition to messages sent by Race Control to Entrants pursuant to Rule 7.1.7.5, Entrants may

send relevant messages to Race Control. Use of the instant messaging system for any reason, including, without limitation, irrelevant, abusive, and/or unnecessarily repetitive messages, may result in monetary penalties.

## **7.2. Flag Codes (“Flags”)**

**7.2.1. Green** - signifies a Green Condition. During all Events:

- a) Practice** – A practice session has begun.
- b) Qualifications** - A qualifications attempt or segment has begun.
- c) Race** – Unless otherwise instructed, a Race has begun.

**7.2.1.1. Road/Street Courses Only-** The Track downstream of a Yellow Condition is clear.

**7.2.2. Yellow** - signifies a Yellow Condition. During Road/Street Course Events:

**7.2.2.1. Local** – A yellow flag is displayed at a marshal’s post.

- a) Stationary** – A standing yellow flag means reduce speed, passing not permitted, be prepared to change direction, a hazard beside or near the edge of the Track.
- b) Waving** - A waving yellow flag means reduce speed, passing not permitted, be prepared to change direction or stop, a hazard wholly or partially blocking the Track.

**7.2.2.2. Full Course** – Standing double yellow flags displayed at all marshal's posts. Waving double yellow flags will be displayed at the post with the hazard.

**7.2.3. Black** - The Driver shall proceed to the pit area on the next lap and follow the instructions of INDYCAR.

**7.2.3.1.** INDYCAR may declare a black flag for a Car if it determines that:

- a) Any condition exists which could cause the Driver or the Driver's Car to create a hazard to the Driver or others;
- b) The Driver has violated a Rule; and/or
- c) The Entrant has requested the black flag

**7.2.3.2.** When a Driver is ordered to the pit lane because of a hazardous condition of the Driver's Car, the proper repairs must be made and approved by INDYCAR before the Car will be permitted to continue in the Event.

**7.2.3.3.** In the event of a violation of the Rules, the black flag may be declared to impose a penalty (a "black flag penalty") which may include repositioning Cars or requiring a Driver to:

- a) Drive through pit lane at pit lane speed limits ("drive through");
- b) Stop in pit lane ("stop and go"); or
- c) Stop in pit lane for a prescribed period ("stop and hold").

**7.2.3.4.** INDYCAR shall determine the type and length of any black flag penalty. Black flag penalties must be implemented under Green Conditions. The penalized Car shall proceed to the pit lane as directed by INDYCAR and may return to competition only upon the declaration of INDYCAR. In the case of a Driver violating the Rules, no work may be performed on a Car during the execution of a black flag penalty. Should any such work occur, the conditions of the penalty are unfulfilled and the penalty procedure must be executed again in its entirety on a subsequent lap. The penalty may not be protested and/or appealed.

**7.2.4. Black with White Cross** – INDYCAR has ceased scoring the Car indefinitely.

#### **7.2.5. Blue Flag**

**7.2.5.1.** An approaching Car is attempting to overtake and the Car being signaled must give consideration to the overtaking Driver.

**7.2.5.2.** At Road/Street Course Events, when displayed from the starters stand to a lapped Car, as ordered directly by INDYCAR, the blue flag is a command to immediately give way. During the Race, any Car failing to give way within one (1) lap of the display of the blue flag from the starters stand will be penalized.

**7.2.5.3.** At Oval Events, the blue flag will be displayed from the starter stand as per Rule 7.2.5.1, unless ordered by INDYCAR. At that time, the blue flag is a command to immediately give way, and any Car failing to give way within one (1) lap of the display of this blue flag will be penalized.



## **7.2.6. White**

**7.2.6.1. Oval Event Qualifications** - The Car has commenced its last lap.

**7.2.6.2. Road/Street Course Practice/Qualifications** - When displayed from a marshal's post, a Car or safety vehicle is not at full speed on the Racing Surface.

**7.2.6.3. All Races**– When displayed from the starter's stand, the leader has commenced his/her last lap and will continue to be displayed to all successive Cars as they cross the finish line.

**7.2.7. White with Red Cross** - When displayed from the starters stand, safety vehicles and/or personnel are on Track.

**7.2.8. Alternating Red and Yellow Stripes** - Oil, water or other substance has altered the Racing Surface.

**7.2.9. Checkered** - The practice session, qualifying session or Race is completed. All Drivers must enter the pits after receiving the checkered flag.

**7.2.9.1. Road/Street Courses** - The checkered flag will be displayed at the marshal's post nearest the alternate start/finish line at the end of practice and qualifying sessions. All Drivers must immediately enter the pits after receiving the checkered flag at this point.

**7.2.9.2. Final Practice Sessions** – The checkered flag will be displayed at the start/finish line.

**7.2.9.3. Race** – The checkered flag will be displayed to the Race leader at the start/finish line upon the

completion of the Race Leader's final lap and will continue to be displayed until each Car running has received the checkered flag.

#### **7.2.10. Red** – Signifies a Red Condition.

**7.2.10.1.** Unless otherwise declared by INDYCAR, a Race stopped by the declaration of a Red Condition will be considered incomplete unless more than 50% of the scheduled number of laps has been completed by the Race leader. If INDYCAR schedules the continuation of the Race on a subsequent date or a later time, the Race will be restarted beginning with the unfinished portion of the scheduled number of laps.

**7.2.10.2.** If a Race is stopped by the declaration of a red condition and more than 50% of the scheduled number of laps have been completed by the Race leader, INDYCAR may declare the Race complete and final standings will be determined by ranking all Cars in order by total laps completed and sequence of completion through the last official Race lap.

**7.2.10.3.** Officials will make reasonable effort to restart a Race stopped by the declaration of a Red Condition if the conditions warrant.

**7.2.10.4.** INDYCAR's decision to restart or not to restart a Race stopped by the declaration of a Red Condition may not be protested and/or appealed.

### **7.3. Timing and Scoring**

#### **7.3.1. Race Distance and/or Time Limit**

**7.3.1.1.** INDYCAR shall announce the scheduled number of laps and/or time limit prior to the start of a Race.

**7.3.1.2.** If INDYCAR determines that there are time limitations due to weather, curfew, or otherwise, INDYCAR may move the start time of a Race, shorten the distance of a Race, set a maximum time for a Race, or take such other actions as it deems appropriate.

### **7.3.2. Systems**

**7.3.2.1.** The electronic scoring system is the primary scoring record. INDYCAR will record the physical sequence in which each Car crosses the start/finish line, including in pit lane.

**7.3.2.2.** INDYCAR may use other substantiating scoring systems.

**7.3.2.3.** If INDYCAR cannot visually determine the position of a Car relative to other Cars, INDYCAR may consult with other Officials and access such other data as it determines necessary or appropriate to assist him in determining the order of the Cars.

**7.3.3. Start/Finish Line** - The scoring of Cars shall begin at the moment when the timing transponder of the lead Car reaches the starting line and the declaration of the Green or Yellow Condition has been given by the INDYCAR.

**7.3.3.1. Ovals and Indianapolis 500® Mile Race**  
- A single start/finish line will be defined across the Track, and extended across the pits where appropriate, in the immediate area of the starter's stand.

**7.3.3.2. Road/Street Courses** - INDYCAR may designate separate start/finish lines.

#### **7.3.4. Lap Credit**

**7.3.4.1.** A Car will be credited with a lap when its timing transponder crosses the start/finish line after completing one entire lap of the Track with two wheels of the Car having remained on the Racing Surface at all times, as determined from the scoring records. Notwithstanding the foregoing:

**7.3.4.1.1.** If a Car returns to pit lane under its own power and retires from the Race, INDYCAR may credit the Car with completion of the lap.

**7.3.4.1.2.** On the last lap of a Race, a Car will be officially credited with a lap when any part of the Car under its own power crosses the finish line.

**7.3.4.1.3.** A Car will not be permitted to advance or maintain its position relative to other Cars due to an excursion off the Racing Surface unless the excursion was due to the Car taking evasive action.

**7.3.4.2.** A Car shall be considered the first Car out of the Race and shall be awarded the final finishing position based on the following order:

- a)** The Car is a non-starting Car pursuant to Rule 10.3.6,
- b)** The Car does not leave the starting grid and does not return to the Race,

c) The Car drops out during the parade or pace laps, or

d) The Car drops out of a Race before completion of the first lap.

**7.3.4.2.1.** In the event more than one Car is affected in one of the above categories, INDYCAR shall rank such Cars based on their original starting grid positions.

**7.3.4.3.** Final standings will be determined by the sequence in which the Cars completed the scheduled number of laps.

**7.3.4.3.1.** Except as provided in Rule 7.3.4.1.2, a Race will be completed by the Race winner at the moment the timing transponder of the Car crosses the finish line on the last lap. The Race will be completed by each other Car when the timing transponder of each Car crosses the start/finish line after the Race leader. Scoring will thereafter cease, and the Race is completed. INDYCAR's decision may not be protested and/or appealed.

**7.3.4.3.2.** Cars not completing the scheduled number of laps will be ranked in order by total laps completed and sequence of completion, whether the Car is still running or not. INDYCAR shall determine the "reason out" for each Car not listed as running. INDYCAR's decision may not be protested and/or appealed.

### **7.3.5. Ties**

**7.3.5.1.** In the event INDYCAR is unable to conclusively determine any difference in the physical

sequence for two or more Cars at the end of a Race, INDYCAR shall determine the finishing positions based upon the Cars' positions at the finish line on the prior lap.

**7.3.5.2.** In the event two or more Cars post the identical number of laps led in a Race, the Car finishing the Race in the higher/highest position will earn the two points or award for most laps led.

**7.3.5.3.** INDYCAR's decisions are not subject to protest and/or appeal.

#### **7.4. Pit Locations/Selection**

##### **7.4.1. Non Indianapolis 500® Mile Race Events –**

Except as otherwise provided in the Rules, pit locations for Race Locations shall be determined based upon the Entry's position in the qualifications results (inclusive of penalties) at the previous Race Location. Pit locations will begin with the pole position Entry receiving the stall at pit out and continuing through the qualifications results to Pit In. Team pits will not be averaged.

**7.4.1.1.** If an Entry did not participate at the prior Race Location, it shall be assigned as follows:

- 1)** Driver points
- 2)** Blind draw

**7.4.1.2.** In the event of a Driver replacement for medical reasons, the Entry will retain the pit location per Rule 7.4.1.

**7.4.1.3.** With the exception of Rule 7.4.1.2, Entry changes received after the close of business Tuesday following qualifications at the previous Race

will be placed in the pit location nearest to pit in, in the order changes are received by INDYCAR.

**7.4.1.4.** For the first Race Location of the season, pit locations shall be assigned based upon prior season ending Entrant point standings. INDYCAR shall determine an Entrant or Entry's eligibility. Entries without points shall be assigned by the date that Entry was received.

**7.4.1.5.** If qualifications do not occur at the prior Race Location, pit locations for the subsequent Race Location shall be assigned based upon the starting positions (not qualification results) established at the prior Race pursuant to Rule 8.1.10.1.

**7.4.1.6.** At a Double-Header Race Location, the pit location will not be moved between Race One and Race Two. Race Two qualifications will determine the next Events Location pit selection.

## **7.4.2. Indianapolis 500® Mile Race:**

**7.4.2.1. Practice** - Following the Indianapolis Road Course Race, all Entrants are required to move all of their Pit equipment out of pit lane to the garage area, and Entrants will be permitted to move equipment back into their designated pit location Sunday, May 11th, 8:00 AM. Pit locations shall be selected by an Entry based upon the Entry's position in the current Entrant point standings following the Indianapolis Road Course Race. A Team shall average all combinations of its Entries so as to group them together in pit lane. If a Team with points has an Entry without points, this Entry will not be calculated into the average. In addition, partial season Entries will not be calculated into the average. INDYCAR shall determine an Entrant or

Entry's eligibility. Entries without points shall be ranked at the end of the point standings by date of Entry receipt.

Pit Selection shall be conducted in the N1 Office on Saturday May 10<sup>th</sup> at 6:00 PM (E.D.T). INDYCAR shall assign a pit location for any Entry not represented at the designated pit selection time and place. Following the conclusion of practice on Friday, May 16<sup>th</sup>, an Entrant must move its pit equipment from the practice pit location to the qualifications pit location.

**7.4.2.2. Qualifications** – Pit locations shall be assigned by INDYCAR based upon the position of the Entry's primary Car in the initial qualifications draw. The pit location for the first primary Car will be the first pit north of Gasoline Alley and continue north through the selection order. Three Cars will be assigned to two pits. A Team shall not have the option to average its Entries. The pit locations will be distributed after the draw is completed, and Entrants may move their pit equipment to their qualifications pits at that time. The same pit assignments will be in place for all qualification days.

**7.4.2.3. Carburetion Day/Race Day** - Pit locations shall be selected by an Entry based upon the Entry's qualifications position at the close of qualifications. A Team shall have the option to average any combination of its Entries so as to group them together in pit lane. INDYCAR shall determine the time and place for the pit selection. INDYCAR shall assign a pit location for any Entry not represented at the designated pit selection time and place. After the close of Qualifications on Sunday, May 18<sup>th</sup>, an Entry's pit equipment must be moved from the Qualification pit location to the garage area until



notice from INDYCAR to move to its designated pit for Race Day.

## **7.5. Race Start**

### **7.5.1. Rolling Starts**

**7.5.1.1.** The Car starting from the first position will start from the inside of the front row. All Drivers must place their Cars in their respective positions on the parade and pace laps. If a Car experiences mechanical difficulty, the Car may return to its original starting grid position any time prior to the conclusion of the parade lap. After this time, the Car shall be moved to the rear of the starting grid. If more than one Car is so affected, INDYCAR shall determine the order at the rear of the starting grid. The remaining Cars in the field must maintain their assigned positions unless otherwise instructed by INDYCAR.

**7.5.1.2.** Cars dropping out on the parade or pace laps may be considered cause for delaying the start. Such Cars will be directed to the pit lane or another designated area and will be permitted to join the Race under the direction of INDYCAR whenever their difficulty is corrected. Unless otherwise instructed, their first scored lap must begin at the starting line on the Racing Surface.

**7.5.1.3.** A Safety Car will be used to pace the field at the start of the Race. The Safety Car will have its flashing lights on during the parade and pace laps. At the appropriate time, the lights will be turned off, indicating intent to start the Race the next time across the starting line. The Safety Car will pull off into the designated location. The lap count may begin at the conclusion of the pace lap.

**7.5.1.4.** All Drivers must maintain their relative positions until the Green Condition is declared. If a Driver improperly improves his/her position prior to the declaration of the Green Condition, the Driver may be penalized. The imposition or non-imposition of a penalty may not be protested and/or appealed.

**7.5.1.5.** Upon INDYCAR's declaration, all Cars must start a Road/Street Course Race on "wet tires". While changes may be made to the Cars on the grid to accommodate the "wet tires", the Entrant remains responsible for complying with post-Race technical inspection. After such a declaration has been made, Entrants may change to dry tires after taking the green flag on the Track.

## **7.5.2. Standing Starts**

### **7.5.2.1. Formation Laps**

**7.5.2.1.1.** All non-Officials must completely clear the pre-grid.

**7.5.2.1.1.** The Safety Car will start the formation lap and the Drivers will follow in single file, starting order.

**7.5.2.1.2.** If a Car is unable to leave the pre-grid with the rest of the field, it may return to its original starting grid position any time prior to the conclusion of the first formation lap.

- a) Cars that leave the pre-grid but do not return to their original starting position prior to the conclusion of the first formation lap must start from the rear of the field.

**b)** Cars unable to leave the pre-grid during the first formation lap must start from their assigned pit location and must be released by INDYCAR.

**7.5.2.1.3.** There will be 2 formation laps. During the formation laps, Drivers will remain in starting order with no overtaking and the speed will be set by the Safety Car. Coming to a complete stop to undertake practice starts is prohibited.

### **7.5.2.2. Grid**

**7.5.2.2.1.** All non-Officials and crew are strictly prohibited from the grid.

**7.5.2.2.2.** At the end of the formation laps, the Safety Car will pull away from the field and the field will take their starting positions. The front wheels of the Car must remain within the orange grid line.

### **7.5.2.3. Light Sequence**

**7.5.2.3.1.** When all Cars are in position on the grid a five (5) second signal will be given by illuminating one pair of red lights. A countdown to the start will illuminate a pair of red lights every second.

**7.5.2.3.2.** After a random delay of between 0.5 and 4.0 seconds, the race is started by all the red lights being extinguished. **(See illustration).**



**7.5.2.3.3.** Any Cars determined to cause a delay of the start will be penalized.

**7.5.2.4. False Start** - A false start shall be declared when a Car moves forward or is out of its assigned position during the light sequence.

**7.5.2.4.1.** A penalty will be imposed for a false start. Decisions are not subject to protest and appeal.

**7.5.2.4.2.** An Official may be stationed at each row on the starting grid. A waving yellow flag by this Official is an advisory of a disabled Car.

**7.5.2.5. Aborted Start** –INDYCAR can declare an aborted start prior to the final row of red lights illuminating in the light sequence.

**7.5.2.5.1.** In the event of an aborted start, flashing yellow lights will be displayed along the top row of all columns and the countdown lights will freeze in their current state. (**See illustration**)



**7.5.2.5.2.** New formation lap - an extra formation lap will be carried out after the first attempt of an aborted start. Approximately two (2) seconds after the yellow aborted lights are illuminated, green lights will be illuminated to start the new formation lap. (**See illustration**)



**7.5.2.5.3.** Any Competitors whose actions are determined to be the cause of an aborted start will restart from the rear of the field.

**7.5.2.5.4.** If the second attempt of a standing start results in an aborted start, Rule 7.5.1 will be in effect.

**7.5.2.6. Timing and Scoring** – The scoring of the Race and all scoring shall commence when the light sequence has begun.

## **7.6. Race Restart**

### **7.6.1. After a Yellow Condition**

**7.6.1.1.** Prior to the restart, any Cars between the Safety Car and the Race leader will be waved by to join the rear of the field. Waved by Cars may pit. INDYCAR may restart the Race prior to the waved by Cars having joined the rear of the field.

**7.6.1.2.** After the starter gives the “one (1) lap to go” signal and prior to the restart, Cars must line up in double file formation. The Car starting from the first position will start from the inside of the front row. All other Cars must line up according to relative position on the Track. In the event of a restart with 15 laps or less remaining, all lapped Cars will be moved to the rear of the field.

**7.6.1.3.** When the Track is clear for racing, the Safety Car will assist the field in preparing for a restart. At the appropriate time, the flashing lights will be turned off, indicating intent to restart. The leader is required to maintain the pace lap speed until reaching a point designated by INDYCAR near the start/finish line when the leader shall accelerate smoothly back to racing speed and the Green Condition will then be declared. All Car(s) must maintain their respective Track positions until the Green Condition is declared.

**7.6.1.4.** During the Yellow Condition, no Car may pass another Car unless:

**7.6.1.4.1.** The other Car is stopped on the Track or the Driver of the other Car has waved by all of the passing Cars in a safe location and promptly confirms such action by radio communication to INDYCAR;

**7.6.1.4.2.** The other Car is not maintaining the pace lap speed; or

**7.6.1.4.3.** Either Car is in the pit lane boundaries.

**7.6.1.5.** The penalty for passing the Safety Car or another Car during a Yellow Condition without authorization by Officials shall be a black flag, lap(s) or such other penalty, as INDYCAR deems appropriate.

**7.6.1.6.** INDYCAR shall determine the restart procedures, as it deems appropriate. This includes when to give the proper passing signal, whether a proper passing signal has been given, whether to move lapped Cars to the rear of the field, whether the leader or any other Car fails to restart the Race as directed, and the type and timing of any penalty. All such decisions made by INDYCAR may not be protested and/or appealed.

**7.6.1.7. Indianapolis 500® Mile Race** – All of the standard restart procedures shall apply with the following exceptions:

- a) Cars must line up in single file format on the backstretch “nose to tail”.
- b) The leader is required to maintain the pace lap speed until reaching a cone located on Driver’s right entering turn four.

- c) All Car(s) must maintain their respective Track positions for the restart, including without limitation not changing lanes, until the Green Condition is declared. After the Green Condition is declared, passing may occur.

**7.6.2. After a Red Condition**— All of the standard restart procedures shall apply with the following exceptions:

**7.6.2.1.** The Cars will be lined up in order beginning with the Race leader. The restart order of the remaining Cars will be determined by their physical sequence at the start/finish line during the last scored Race lap.

**7.6.2.2.** Notwithstanding Rule 7.6.2.1, the following reasons may be cause for a Car to be placed at the rear of the restart lineup:

- a) Cars involved in a crash during, or subsequent to, the last scored lap. The decision as to whether a Car has been involved in a crash may not be protested or appealed;
- b) Cars stopped on the Track, including the pits, during the last officially scored lap; and/or
- c) Cars which undergo a change of Driver during the time the Race is stopped.

**7.6.2.2.1.** The restart order of Cars placed at the rear of the lineup will be in order by total laps completed and sequence of completion.

**7.6.2.3.** Any laps being run under a Yellow Condition will be scored. Any Cars remaining in pit lane at the



time of a restart may join the Race if approved to compete by INDYCAR.

## **7.7. Mechanical Conditions**

**7.7.1.** INDYCAR shall determine whether a Car involved in a crash or with a hazardous mechanical condition will be permitted to continue in the Event or must first return to the pit lane or the garage area for necessary repairs.

**7.7.2.** INDYCAR shall determine how the Car is removed and where the Car is taken. INDYCAR is not responsible for payment, reimbursement, damage, or loss to any Car as a result of such removal and with respect to the location to which the Car is taken.

**7.7.3.** After any repairs have been completed by the Entrant's crew, the Car is subject to visual or other inspection by INDYCAR prior to and/or during any further competition. If INDYCAR determines that further repairs are warranted, the Entrant's crew must make those repairs before the Entrant's Car is permitted to return to competition.

**7.7.3.1. Oval Races** – Cars being repaired will not be permitted to return to the Race during the last 20 laps of the Race.

**7.7.3.2. Road/Street Course Races** - Cars being repaired will not be permitted to return to a Race during the last 10 laps of the Race.

**7.7.4.** A Car may only receive on Track assistance as directed by INDYCAR.

**7.7.5.** Officials may approve technical or structural changes during technical inspection due to contact, material, or parts failure.

**7.7.6.** These decisions of INDYCAR are final and may not be protested and/or appealed.

## **7.8. Performance Standards**

**7.8.1.** INDYCAR may establish a performance standard which all Entries entered in an Event must achieve in order to participate in the Event. In general, Entries must perform within 105% of the Car posting the best time and demonstrate Car consistency, control/placement, and interaction with other Cars on Track to the satisfaction of INDYCAR. In general, the performance standard will be announced to all Competitors prior to the start of the first practice session and will not be raised after practice has started. However, INDYCAR may delay announcement of the standard until a later time based on the physical condition of the Track, safety, and other considerations.

## **7.9. Pit Procedures**

**7.9.1.** INDYCAR may declare Race conditions for any on-Track activity.

**7.9.2.** Any on-Track activity declared to be run under Race conditions requires attire for pit personnel as set forth in Rule 1.2.7.2.

**7.9.3.** Cars will not be permitted to enter or exit the garage area under their own power. They must be pushed or towed with a Member in the Car who is able to access the brake pedal at all times.

**7.9.4.** All Cars must be centered in their assigned pits. The outer point of the inside rear tire must not exceed a maximum of four feet (48 inches) from the front face of the pit wall. The Car must be parallel to the pit wall.

- 7.9.5.** For each Car, a maximum of six (6) crew members plus the Driver are permitted on the Track side of the pit wall at any one time when the Car is making a pit stop. They may assume their positions immediately before the Car arrives.
- 7.9.6.** Equipment and tires on the Track side of pit wall must be attended by a crew member at all times. The outside front tire changer must have his/her foot on the tire until the Car enters the pit.
- 7.9.7.** Except during a pit stop, no personnel or pit equipment, including tires, may be on the Track side of the pit wall.
- 7.9.8.** An Entrant is not permitted to utilize a signboard without INDYCAR approval.
- 7.9.9.** Illuminated devices used in the pit box during an Event must be approved by INDYCAR.
- 7.9.10.** No individual shall stand or sit on the pit wall.
- 7.9.11.** Except as otherwise provided by the Rules, all personnel and equipment must remain within the assigned pit.
- 7.9.12.** A speed limit of 50mph at all Road/Street Course Events and 60mph at all Oval Events will be enforced within the pit lane areas defined by painted lines, cones and/or other visible markings.
- 7.9.13.** Fueling with the aid of pumps, open containers or any other device is not permitted. Only fuel from the pit fuel storage tank may be added to the Car.
- 7.9.14.** During practice, fuel may only be added through the practice dry-break vent system. The Engine must be

shut off during any practice refueling. A crew member must operate fire equipment during any refueling.

**7.9.15.** The use of the fuel probe without flowing fuel during practice sessions is permitted in accordance with Rule 7.9.13.

**7.9.16.** A Driver who passes the Driver's assigned pit by more than one pit must continue around the Track and stop on the next available lap.

### **7.9.17. Courtesy Zones**

**7.9.17.1.** Any Participant who, in the opinion of INDYCAR, positions a Car, equipment, and/or personnel so as to create a hazard or disruption of the Event or to interfere with the activities of another Competitor may be penalized.

## **7.10. Pit Safety Violations**

**7.10.1.** Any of the following matters and any others which may be determined by INDYCAR may be cause for a Car to be penalized:

**7.10.1.1.** Failing to follow designated procedures entering or exiting the pit area, including the acceleration and deceleration lanes;

**7.10.1.2.** Leaving the assigned pit with air hoses, fuel hoses, tools or other equipment attached to or hanging from the Car;

**7.10.1.3.** Car passing over or under any air line or hose or any other equipment;

**7.10.1.4.** Car contact with pit equipment outside of standard pit stop procedures;

**7.10.1.5.** Contact with another Car;

**7.10.1.6.** Contact with personnel;

**7.10.1.7.** Pit personnel not wearing proper attire as set forth in Rule 1.2.7.2;

**7.10.1.8.** More than six crew members are on the Track side of the pit wall during a Race;

**7.10.1.9.** Car entering a pit other than the Car's assigned pit.

**7.10.2.** Penalties for violations of this Rule include, but are not limited to, a black flag and/or exclusion from the Event. No such decisions may be protested or appealed.

## 8. QUALIFICATIONS

### 8.1. All Race Locations

**8.1.1. Overview** - This Rule 8.1 contains qualifications Rules for all Race Locations. Qualifications determines the eligibility and starting position of each Car desiring to participate in a Race by ranking the Car on the basis of its performance in qualifications.

**8.1.2. Meeting** – INDYCAR may hold a specific meeting prior to the start of any qualifications. INDYCAR may designate the meetings as mandatory for some Members.

**8.1.3. Starting Time** - INDYCAR shall determine the starting time for the qualifications period.

**8.1.4. Delays** - INDYCAR may penalize any Member attempting to delay or delaying qualifications.

### 8.1.5. Interruption and Suspension

**a) Interruption** - Qualifications may be interrupted by the commencement of a Yellow or Red Condition. Qualifications is interrupted at the moment that the decision to interrupt is made.

**b) Suspension** – INDYCAR may suspend qualifications for any reason.

**c)** The decision to interrupt or suspend an attempt or qualifications (and reasons therefore) may not be protested and/or appealed.

## **8.1.6. Technical Inspection**

**8.1.6.1. Impound Area** - Officials shall direct selected Qualified Cars to a designated "impound area" to check for compliance. A maximum of two crew members per Car will be permitted in the impound area.

**8.1.6.2. Cars** – INDYCAR reserves the right to seal any component.

**8.1.6.3. Fuel** - A fuel sample may be taken from all Cars prior to and after the qualifications attempt.

**8.1.6.4. Battery** - An external battery may be connected to the Car when the Car is in the qualifying line.

**8.1.6.5. Technical Violations** - If a Car does not successfully complete post-qualifying technical inspection, INDYCAR will penalize the Car.

**8.1.6.6. Qualified Cars** - All qualified Cars must remain on the grounds of the Race Location after qualifications unless otherwise permitted by INDYCAR.

**8.1.7. Backup Cars** - If a qualified Car is involved in a crash prior to the Race, INDYCAR may permit the Entrant to start a Backup Car in its original qualifying position, as indicated below:

- a) INDYCAR must approve any Car substitution.
- b) The Driver must be approved by INDYCAR in accordance with Rule 1.2.3.3.

- c) This decision is not subject to protest and/or appeal.

### **8.1.8. Starting Field**

**8.1.8.1.** INDYCAR shall determine the size and configuration of the starting field for each Race. The size of the starting field shall be issued by INDYCAR bulletin. The configuration of the starting field may include qualified and non-qualified Cars. The performance standard shall apply to all Cars at all times during an Event.

**8.1.8.2.** Except for those positions designated for Provisional Starting Cars and as otherwise provided by these Rules, the starting field shall be determined by best time rankings, from fastest to slowest, with the fastest qualifier occupying the pole position, followed by the second fastest qualifier, third fastest, etc., down through the slowest qualifier who has not been "bumped".

**8.1.8.3.** In the event two or more Cars post identical official qualifications times, the Cars shall be ranked in the order in which the completed qualifications attempts occurred.

**8.1.8.4.** A Driver who has qualified a Car may not make an attempt to qualify a second Car unless the first Car has been withdrawn from the Event with permission of Officials or the first Car has been eliminated from the starting field.

**8.1.8.5.** INDYCAR shall determine whether the starting field shall include Provisional Starting Cars. INDYCAR shall announce such decision prior to each Event. If Provisional Starting Cars are offered, the available starting positions shall be determined



pursuant to Rule 8.1.8.2, and the provisional starting positions shall be determined pursuant to Rule 8.1.9. If Provisional Starting Cars are not offered, all starting positions shall be filled pursuant to Rule 8.1.8.2. Starting positions shall include penalties issued during qualifications and post-qualifications technical inspection.

**8.1.8.6.** If after qualifications and prior to the start of a Race a Car has had its qualifications time, and/or original starting grid position disallowed, INDYCAR shall assign the Car a revised starting grid position at the rear of the starting field based on the following order:

- a) Provisional starting Cars;
- b) Alternate starting Cars;
- c) Unapproved Engine change;
- d) Technical violations;
- e) Competition violation; and
- f) Substitute starting Driver.

**8.1.8.6.1.** If more than one Entry is affected in one or more of the above categories, INDYCAR shall rank such Cars based upon Entrant points entering the Event.

**8.1.9.** Provisional Starting Cars (Except at the Indianapolis 500® Mile Race) - INDYCAR may offer up to a maximum of two (2) Provisional Starting Cars at each Event after the conclusion of qualifications among non-Qualified Cars based on the following formula:

**8.1.9.1.** The first provisional starting position will be assigned to the Car driven by the 2013 IndyCar Series champion Driver.

**8.1.9.2.** The next position will be assigned to the Car driven by the 2012 IndyCar Series champion Driver.

**8.1.9.3.** The next position will be assigned to the Car driven by the 2013 Indianapolis 500® Mile Race champion Driver.

**8.1.9.4.** The next position(s) will be assigned to the Car driven by the highest-ranking Driver(s) in the current top 24 Drivers point standings prior to the current Race.

**8.1.9.5.** The next position(s) will be assigned to the Leaders Circle Program Member(s) with the best practice lap time at the Event, provided the best lap time is an acceptable time as determined by INDYCAR.

**8.1.9.6.** If the positions are not filled by provisions 1-5, then the positions will be filled by the Car with the next best lap time posted during qualifications, provided the best lap time is an acceptable time as determined by INDYCAR.

#### **8.1.10. Starting Field Determination**

**8.1.10.1. No Qualifications/Qualifications Not Completed** – With the exception of positions designated for Provisional Starting Cars, INDYCAR shall assign all starting positions as follows:

- a)** At the First Race of the season, the Cars shall be ranked using the prior season's Entrant point

standings. INDYCAR shall determine an Entrant's eligibility.

b) Entrant point standing entering the Race.

#### **8.1.10.2. Qualifications Completed/Open**

**Positions** - Qualifications have been completed, but all available starting positions have not been filled. With the exception of positions designated for Provisional Starting Cars, INDYCAR shall assign open starting positions based on the priority in Rule 8.1.10.1.

### **8.2. Ovals**

**8.2.1.** Rule 8.2 contains qualifications Rules for Ovals which are in addition to the Rules for all Race Locations contained in Rule 8.1 to the extent not inconsistent with them. In the event of any inconsistency, this Rule 8.2 shall govern Ovals.

**8.2.2. Qualifications Order** – INDYCAR shall determine the qualifications order by a blind draw. An Entrant's representative may only draw for an entered Car. If an Entrant does not have an authorized representative present at the drawing, INDYCAR will draw for the unrepresented Car.

#### **8.2.3. Qualifications Line**

**8.2.3.1.** Cars must be in the qualifications line at the technical inspection area at the following designated times before the beginning of qualifications:

30 minutes.....First third of the line  
15 minutes.....Middle third of the line  
Qualifications begin.....Final third of the line

**8.2.3.1.1.** Qualifying Fuel Procedure – Entries are required to add a minimum of 3.0 gallons of fuel from the fuel depot in the garage area prior to pre-qualification technical inspection.

**8.2.3.2.** A Car reserves its position in the qualifications line as long as it remains in the designated position and proceeds with the qualifications attempt when signaled. INDYCAR's decision of whether a Car is in its designated position is not subject to protest and/or appeal.

**8.2.3.3.** While the Car is in the qualifications line, an Entrant's representatives may make front wing and tire pressure adjustments only. The Car must be moved as the qualifications line progresses. A Car must not leave the qualifications line without the approval of INDYCAR.

#### **8.2.4. Technical Inspection**

**8.2.4.1.** If a Car does not successfully complete pre-qualifying technical inspection as determined by INDYCAR, the Car shall forfeit its "guaranteed attempt" and may be listed at the rear of the starting field pursuant to Rule 8.1.8.6.

**8.2.4.2.** When a Car is presented for pre-qualifications technical inspection, it must be in the aerodynamic configuration in which it shall race, with the following exceptions:

- a)** Fuel fillers and vents may be taped off or fitted with blanking covers;
- b)** Flaps may be adjusted;
- c)** Rear wing mainplane may be adjusted;

- d) Optional wickers may be changed, added or removed;
- e) Inlet shutters may be changed;
- f) Race Location approved aerodynamic options.
- g) Rear wing adjuster may be added and the Dallara supplied lock nuts to limit travel must be installed; and
- h) Radiator screens and vertical internal turning vanes (must comply with Rule 14.6.6.5).

**8.2.4.3.** Retracting the brake pistons into the caliper by any method is prohibited.

**8.2.4.4.** The Car must remain as presented at pre-qualifying technical inspection throughout the entire qualifications attempt unless otherwise approved by INDYCAR.

**8.2.4.5.** Only after a Car's qualifications attempt or post-qualifications technical inspection is completed, whichever occurs later, may any of the foregoing permitted changes be made. Mechanical adjustments within the scope of the regulations are permitted.

## **8.2.5. Declaration of Intent**

**8.2.5.1.** A Car must be presented at the entrance of the "staging pit" when signaled to do so ("declaration of intent"). INDYCAR shall signal a Driver when it is time for the Car to depart from the qualifications line to begin a qualifications attempt. Unless otherwise provided by INDYCAR, each Car

must depart the qualifications line within sixty (60) seconds of receiving the signal.

**8.2.5.2.** In order to make an official qualifications attempt, a Car must have been given the signal to depart from the qualifications line and have moved away under its own power prior to the end of the qualifications period.

**8.2.5.3.** A Car may not be pushed to start its Engine at the start of a qualifications attempt.

**8.2.5.4.** Warm-Up Laps - A Car shall be given two (2) warm-up laps. INDYCAR may add additional warm up laps, as it deems appropriate.

#### **8.2.6. Qualifications Attempt**

**8.2.6.1.** Qualifications will be based on one (1) individually timed attempt per Car. A qualifications attempt is the total of two (2) consecutively timed laps.

**8.2.6.2.** Each Car will be permitted only one (1) departure from the qualifications line to commence its qualifications attempt. A qualifications attempt may only be started and completed under the Green Condition.

**8.2.6.3.** All Cars in the qualifications order shall be given one "guaranteed attempt" to qualify. Notwithstanding the foregoing, the following matters and any others as determined by INDYCAR are cause for a Car to forfeit its guaranteed qualifications attempt and to be listed at the rear of the starting grid in accordance with Rule 8.1.8.6.

- a) A Car is not presented in the proper order at technical inspection at the designated time;
- b) A Car does not successfully complete technical inspection;
- c) A Car is not presented in the proper order at the staging pit;
- d) A Car fails to leave the staging pit within the designated time;
- e) A Car leaves the staging pit but fails to receive the green flag; or
- f) A Car fails to receive the checkered flag.

**8.2.6.3.1.** If more than one Car is so affected, the Cars shall be ranked according to Rule 8.1.8.6.

**8.2.6.4.** Prior to Engine start, all computers or any other external devices must be disconnected. Cars experiencing Engine start difficulties must have approval from INDYCAR prior to connecting any device.

**8.2.6.5.** If the field is full (except for those positions designated for Provisional Starting Cars), qualifications attempts may continue with the potential for the elimination of the slowest qualifier ("bumping"). When a subsequent qualifier completes a qualifications attempt at a better lap time, the slowest Qualified Car is eliminated from the field, and the faster qualifier is inserted into the field based on best lap time ranking. This process

continues until each Car has been given its guaranteed qualifications attempt.

**8.2.6.6.** If the field is not full but the qualifications period has ended and each Car has received its guaranteed attempt, all Cars successfully completing qualifications attempts shall be “locked in” and the remaining available starting positions, except those designated for Provisional Starting Cars, shall be determined in accordance with Rule 8.1.10.2.

**8.2.6.7.** If the qualifications period concludes before each Car has been given its “guaranteed attempt”, then qualifications shall resume at a time designated by INDYCAR, if practicable. If INDYCAR is unable to resume qualifications and allow each Car its guaranteed attempt, the entire starting field shall be determined in accordance with Rule 8.1.10.1

**8.2.6.8.** If INDYCAR interrupts qualifications for reasons caused by a Driver or the Driver’s crew, the Driver’s Car shall forfeit its guaranteed qualifications attempt and may be listed at the rear of the starting grid in accordance with Rule 8.1.8.6. If the interruption is not due to the actions of the Driver or the Driver’s crew, the Car shall not be charged with its qualifications attempt and the Car may be permitted to return to its position at the front of the existing qualifications line and proceed with its guaranteed qualifications attempt.

**8.2.6.9.** If a Car has started its warm-up laps or its qualifications attempt before qualifications are suspended, the Car will not be charged with an attempt and will be returned to its position at the front of the existing qualifications line when qualifications resume. INDYCAR shall preserve the qualifications line already established when



qualifications resume. If INDYCAR releases a Car during a suspension, the Entrant is not required to keep its Car at the designated location during the suspension. Officials shall announce prior to resuming qualifications that all Cars are to be returned to the designated location. Any Entrant not returning an Entrant's Car to the designated location by the designated time shall forfeit the Entrant's guaranteed qualifications attempt and may be listed at the rear of the starting grid in accordance with Rule 8.1.8.6.

### **8.3. Road/Street Courses**

**8.3.1.** Rule 8.3 contains qualifications Rules for Road/Street Courses, which are in addition to the Rules for all Race Locations contained in Rule 8.1 to the extent not inconsistent with them. In the event of any inconsistency, Rule 8.3 shall govern Road/Street Courses.

#### **8.3.2. Qualifications Groups**

**8.3.2.1.** For Segment One only, qualifications shall be divided into two (2) groups.

**8.3.2.2.** Qualifications groups shall be determined by the combined times posted by Cars during the practice sessions occurring at the Race Location on the Day prior to qualifications. By way of example, the combined practice times from the Friday morning and afternoon sessions would determine Saturday qualifications groups. If no practice occurs on Friday, the practice times from the first Saturday session would determine Saturday qualifications groups.

**8.3.2.3.** INDYCAR shall rank the Cars in order of time with the Driver posting the best time ranking appearing in the first position and continuing through the rest of the field in order of increasing time. The Driver with the best time ranking shall determine the groups and notify INDYCAR of his/her decision within thirty (30) minutes following the conclusion of the final practice session that determines the qualifications groups.

**8.3.2.3.1.** If the Driver selects Group 1, Group 1 shall contain all Cars appearing in the odd numbered positions on the combined times ranking. Group 2 shall contain all Cars appearing in the even numbered positions on the combined times ranking.

**8.3.2.3.2.** If the Driver selects Group 2, Group 2 shall contain all Cars appearing in the odd numbered positions on the combined times ranking. Group 1 shall contain all Cars appearing in the even numbered positions on the combined times ranking.

### **8.3.3. Technical Inspection**

**8.3.3.1.** When a Car is presented for pre-qualifications technical inspection, it must be in the aerodynamic configuration in which it shall race, with the following exceptions:

- a) Fuel fillers and vents may be taped off or fitted with blanking covers;
- b) Flaps may be adjusted;
- c) Optional wickers may be changed, added or removed;

d) Brake duct options may be changed or blanked off using tape or blanking panels; and

e) Inlet shutters may be changed.

f) Brake disc guards (part #IR1210E005/6 and IR1210G003/4) may be used in trimmed or untrimmed configuration.

g) Brake disc guards (part # IR1210E07/8 and IR1210H012/13) must be used as supplied.

**8.3.3.2.** Entrants are permitted to make only the above aerodynamic adjustments between or during the qualifying segments. Mechanical adjustments within the scope of the Rules are permitted.

**8.3.3.3.** Entrants will be notified after qualifications whether to leave their qualified tires on their Cars for post-qualifications technical inspection.

**8.3.4. Qualifications Attempt** - Qualifications will be divided into three segments:

#### **Segment One**

**8.3.4.1.** All Cars shall participate in one (1) of two (2) groups for ten (10) minutes each inclusive of Red Conditions, with only the six (6) Cars posting the best lap times from each group advancing to Segment Two.

**8.3.4.2.** Segment One shall determine positions thirteen (13) through the end of the starting field. Each group shall be ranked in order of best lap time as follows:

- a) Group one (1) occupy the odd numbered positions beginning with position thirteen (13), and
- b) Group two (2) occupy the even numbered positions beginning with position fourteen (14).

**8.3.4.3.** Group two (2) shall begin five (5) minutes after the conclusion of Group one (1) or as determined by INDYCAR.

### **Segment Two**

**8.3.4.4.** Segment Two (2) shall consist of one ten (10) minute qualifying group inclusive of Red Conditions, with all times from Segment One (1) having been voided. Only the six (6) Cars posting the best lap times shall advance to Segment Three (3). Segment Two (2) shall begin ten (10) minutes after the conclusion of Segment One (1) as determined by INDYCAR.

**8.3.4.5.** Segment Two (2) shall determine positions seven (7) – twelve (12) to be ranked in order of time beginning with the Car posting the seventh best-timed lap occupying the seventh (7<sup>th</sup>) position.

### **Segment Three**

**8.3.4.6.** Segment Three (3) shall consist of one (1) ten (10) minute qualifying group of which five (5) minutes is guaranteed Green Condition time, with all times from Segment Two (2) having been voided. Segment Three (3) shall begin ten (10) minutes after the conclusion of Segment Two (2) as determined by INDYCAR.

**8.3.4.7.** Segment Three (3) shall determine positions one (1) – six (6) to be ranked in order of best lap time beginning with the Car posting the best-timed lap occupying the pole position.

**8.3.5.** If a Car causes a Red Condition in any segment or otherwise interferes with qualifications as determined by INDYCAR, the Car's best two (2) timed laps of the segment shall be disallowed.

**8.3.6.** If a Car causes two (2) Red Conditions in one (1) or more segments or otherwise interferes with qualifications as determined by INDYCAR, all segment times shall be voided, and the Car shall not be permitted to participate in the remainder of qualifying.

**8.3.7.** If a Car interferes with qualifications as determined by INDYCAR:

**8.3.7.1.** If the violation occurs during Segment One or Segment Two, the Car's best two (2) timed laps during that segment shall be disallowed, and the Car shall not advance to the next segment.

**8.3.7.2.** If the violation occurs during Segment Three (3), all Segment Three (3) times shall be voided and the Car shall not be permitted to participate in the remainder of qualifying.

**8.3.8.** The Car starting from the first (1<sup>st</sup>) position will start from the inside of the front row.

### **8.3.9. Double-Header Race 2 Qualifications**

**8.3.9.1.** All Cars shall participate in one (1) of two (2) groups for twelve (12) minutes each, of which five (5) minutes is guaranteed Green Condition time.

**8.3.9.2.** Qualifying groups shall be determined by Rule 8.3.2.2. Group one (1) shall contain all Cars appearing in the odd numbered positions on the combined times ranking and will qualify prior to Group two (2). Group two (2) shall contain all Cars appearing in the even numbered positions on the combined times ranking and will qualify after Group one (1).

**8.3.9.3.** The starting field will be determined as such: the pole position will be awarded to the best overall lap time in the qualifying sessions. The remainder of the cars in that group will be ranked in the odd numbered positions, starting with position three (3). Even numbered starting positions will be determined from the other group, starting with position two (2).

**8.4. Indianapolis 500® Mile Race** – To be issued by Bulletin.

## **9. PENALTIES**

### **9.1. General**

**9.1.1.** INDYCAR may penalize any Member for any violation of the Rules. If an Official observes or is made aware of an act or omission by a Member that constitutes a violation of the Rules and if the Official determines that the act or omission is sufficiently serious to warrant the imposition of a penalty, the Official shall promptly report the violation to INDYCAR. INDYCAR shall consider the report and shall conduct whatever additional inquiry it deems appropriate under the circumstances. After concluding the inquiry, INDYCAR shall determine whether disciplinary action is appropriate, and if so, what disciplinary action should be taken. The Member shall be informed of the determination, and if disciplinary action is imposed, INDYCAR shall issue a penalty notice to the Member specifying the violation, a brief statement of the circumstances of the violation, and the penalty imposed. If the act or omission of a Member is determined by INDYCAR to constitute a threat to the integrity or safety of INDYCAR, the IndyCar Series or to the orderly conduct of an Event or to constitute a violation during an Event, INDYCAR may take immediate action against the Member.

### **9.2. Scope of Penalties**

**9.2.1.** Penalties for violations of the Rules are divided into two categories: race procedure penalties and non race procedure penalties. Regardless of the category, penalties are determined by the gravity of the violation and its effects on fairness of competition, the orderly

conduct of the Event, and the interests and integrity of automobile racing, INDYCAR, and the IndyCar Series. INDYCAR shall have the authority to impose any or all or any combination of the following penalties against any Member for any violations of the Rules at any time.

**9.2.2. Race Procedure Penalties** - are a result of on Track conduct and are generally imposed during on Track activity. If circumstances do not permit a penalty to be served during on Track activity, INDYCAR shall declare the results provisional and subject to review which shall take no longer than two hours after the displaying of the checkered flag. This review is independent of the Competitor's requirement to pass post-Race technical inspection. If the imposition of a penalty is near or at the end of the on Track activity and the Driver/Car does not fulfill it, INDYCAR may reposition the Driver/Car in the posting of results or apply the penalty to a subsequent on Track activity to reflect the fulfillment of the penalty. The penalty including without limitation any repositioning in a posting is non-protetable and/or appealable.

**9.2.2.1. Black Flag** – INDYCAR may impose black flag penalties.

**9.2.2.2. Laps** - INDYCAR may impose lap penalties. Lap penalties shall be imposed in complete laps only. The imposition of a lap penalty shall result in the removal of official credit for the specified number of penalty laps from the total laps credited to the Competitor, and the scoring records and all points and awards shall reflect the removal of penalty laps.

**9.2.2.2.1.** If the lap penalty is imposed during the on Track activity, the removal of official credit shall begin with the Competitor's lap in which



the violation occurred and shall include subsequent consecutive laps, as determined by INDYCAR.

**9.2.2.2.2.** If the lap penalty is imposed after the on Track activity is completed, INDYCAR shall determine, based on the severity of the violation, whether the removal of official credit shall begin with the Competitor's last lap and include previous consecutive laps as required, or begin with the Competitor's lap in which the violation occurred.

**9.2.2.2.3.** INDYCAR shall make a reasonable effort to notify the penalized Competitor of a lap penalty at the time it is determined. However, failure to notify the Competitor during the on Track activity will in no way mitigate or change the penalty.

**9.2.2.3. Time** – INDYCAR may impose time penalties as described below. The imposition of time penalty may result in the following:

**9.2.2.3.1. Subsequent Event:** If the time penalty is imposed for a subsequent on-Track activity, the time shall be removed from the Entrant's Open Test or Team Test, practice session and/or qualifications period. The time penalty must be fulfilled when directed by INDYCAR. The time penalty begins when the Member, the Member's Car, and Entrant personnel are in pit lane.

**9.2.2.3.2. Current Event:** If the time penalty is imposed for the current on-Track activity, time shall be added to the Entrant's overall Race time on the official posting.

**9.2.2.4. Grid** – INDYCAR may impose a grid penalty. A grid penalty is repositioning of an Entrant on the starting grid.

**9.2.2.5. Disqualification** - INDYCAR may disqualify the Member. A sentence of disqualification shall entail the loss of any right to compete in the remainder of the current Event from the time at which the disqualifying condition first occurred. It may entail the forfeiture of Entry fees paid or payable, and INDYCAR shall determine, based on the severity of the violation, whether or not the sentence includes the forfeiture of points and awards earned up to the moment at which time the infraction for the disqualification first occurs.

**9.2.3. Non-Race Procedure Penalties** are a result of on or off Track conduct, but they are typically not imposed during on Track activity. They are protestable and/or appealable unless otherwise noted.

**9.2.3.1. Additional Appearances and/or Meetings** – INDYCAR may require a Member to attend and actively participate in appearances and/or meetings in addition to those required of the Member, other Members, pursuant to the Rules and any other agreements. INDYCAR may specify the due date for completion. Failure to attend and/or participate by the due date may result in reinstatement of the monetary fine if a monetary fine was imposed, or additional penalties as determined by INDYCAR.

**9.2.3.2. Monetary Fines** – INDYCAR may issue monetary fines and specify the due date for payment. Unpaid fines may be deducted from any awards payable by INDYCAR to the Entrant or Manufacturer associated with such Member either

before or after the specified due date. INDYCAR may suspend or refuse to approve the renewal of the License and/or membership of any Member failing to timely pay any fine during the period the fine remains unpaid.

**9.2.3.3. Probation** – INDYCAR may place a Member on probation. Probation is a state of limitation upon a Member's privileges usually following an act or omission occurring before or during membership which calls into question the Member's willingness or ability to abide by standards required for membership. The purpose of probation is to establish a process to allow a Member to prove, by the Member's conduct, that the standards of membership are understood and will be honored at all times. During probation, a Member is under heightened scrutiny and the Member can be required to abide by specified standards of conduct that are more stringent than those which are otherwise applicable to Members under the Rules. If a Member violates probation, the Member is subject to a more severe penalty as determined by INDYCAR. INDYCAR shall determine the duration and conditions of probation.

**9.2.3.4. Suspension** – INDYCAR may suspend a Member. A suspension may be total suspension from INDYCAR or it may be limited to a suspension of membership or License privileges at an Race Location facility or facilities, or for a particular Event or Events, or for a specified or indefinite period of time. Unless expressly limited, a sentence of suspension shall entail the loss of any right to take part in any capacity whatsoever in any Event or Events included in the suspension. Unless otherwise stated, individuals under sentence of suspension will not be issued credentials of any kind for an Event and the privileges and uses of the Track, pit area,

and the garage area will be denied. Every suspended individual shall return all credentials and/or Licenses to INDYCAR who will not return them until the term of the suspension has expired. Any delay in surrendering the credentials and/or Licenses shall be added to the term of the suspension. If the suspended individual does not return the credentials and/or Licenses, the credentials and/or Licenses shall be inoperative and invalid until the lifting of the suspension. Suspension may also render void any previous Entry made for any Event occurring during the term of such suspension and may entail the forfeiture of any applicable Entry fees paid or payable for any such Entries. INDYCAR shall have the right to reduce, increase, or otherwise modify the unexpired term of a sentence of suspension pronounced under the Rules.

**9.2.3.5. Loss of Points and/or Awards** – INDYCAR may rule that a Member who violates the Rules will forfeit all or a portion of the points and/or awards earned in that year, including points and awards earned in the Event in which the violation occurred.

### **9.3. Additional Provisions and Guidelines**

**9.3.1. Improper Conduct** - Any Member attempting to or engaging in unsportsmanlike conduct, unsafe conduct, or conduct detrimental to racing; INDYCAR; and/or to the IndyCar Series, whether during an Event or on/off the Track, may be subject to any or all penalties. Improper conduct shall include, without limitation:

**9.3.1.1.** Engaging in reckless, careless, unsafe, and/or overly aggressive actions, or unsportsmanlike behavior toward Members, or others;

**9.3.1.2.** Impeding the conduct of an Event, including Car control, placement and inconsistent driving pattern;

**9.3.1.3.** Causing an avoidable Yellow or Red Condition;

**9.3.1.4.** Endangering the safety of Members, or others;

**9.3.1.5.** Failing to participate at competitive speed;

**9.3.1.6.** Failing to participate in close proximity to other Cars;

**9.3.1.7.** Failing to follow the direction of INDYCAR; and/or

**9.3.1.8.** Using improper, profane, or disparaging language or gestures in reference to any Official, Members or anyone else improper, profane or disparaging language or gestures in reference to, concerning or connected in any way with INDYCAR, the IndyCar Series, or any Event and could result in additional penalties as determined by INDYCAR.

**9.3.2. Blocking** – A Driver must not alter his/her racing line based on the actions of pursuing Drivers to inhibit or prevent passing. Blocking will result in a minimum of a black flag “drive through” penalty.

**9.3.3. Avoidable Contact** – A Competitor must not initiate or attempt to initiate avoidable contact that results in the interruption of another Competitor’s lap time or Track position.

**9.3.4. Team Tactics and/or Orders** – Team tactics and/or orders on the Track are prohibited. If INDYCAR

determines one or more Members of a Team attempted to or engaged in team tactics or orders, INDYCAR may issue a black flag penalty to any or all of the Team's Car/Driver combinations in addition to other penalties.

**9.3.5. Assault or Battery** - If any Member shall commit an assault or battery during or in connection with an Event, such Member may be disqualified and/or suspended by INDYCAR and may be subject to additional penalties.

**9.3.6. Gambling on Events** - Applicants and Members shall not engage, nor attempt to engage, in any gambling activity (as defined below) relating to any Event, or any portion of an Event, (i) in which INDYCAR is involved, including, but not limited to, IndyCar Series, Indy Lights, Pro Mazda Championship and/or USF2000 National Championship events, or (ii) that in the judgment of INDYCAR could represent and represents the potential for a conflict of interest, unsportsmanlike conduct or conduct detrimental to racing and/or INDYCAR Group. This Rule applies to all gambling activities including, without limitation, those available in any gaming facility, casino, lottery gaming facility, racetrack gaming facility, or on the internet or electronically, or in all other establishments and locations. Gambling activity, for purposes of the above, is defined as placing anything of value at risk, whether monetary or otherwise, in connection with a bet, wager, or game of chance. If an applicant or Member wishes to participate in any gambling activity associated with or related to INDYCAR or its affiliates (for example, a celebrity blackjack tournament), he/she may do so only if he/she has received the prior written authorization of INDYCAR. Such authorization, if granted, will be limited to the extent authorized by INDYCAR.

**9.3.7. Personal Criticism of Officials** – If any Member uses improper, profane or disparaging language or gestures and references a specific Official by his/her name or title, such Member may be fined a minimum of \$25,000 and/or may be subject to additional penalties based upon the particular circumstances.

**9.3.8. Social Media** – Competitors and Officials must comply with provisions of the INDYCAR Social Media Policy at all times.

## **10. CHAMPIONSHIP, POINTS & POINTS FUND**

### **10.1. Championships and Point Standings**

**10.1.1.** INDYCAR recognizes several different types of championships, including, without limitation, Engine Manufacturer, Entrant, and Driver. To facilitate competition for these championships, INDYCAR calculates and publicizes complete rankings of all participating Engine Manufacturers, Entrants and Drivers following the completion of each Race. Unless otherwise announced by INDYCAR, all scheduled qualifications and Races shall offer championship points.

### **10.2. Significance of the Car Number**

**10.2.1.** Points and awards are credited only to the Engine Manufacturer supplying the Engine, Entrant entered in the Event and to the Driver starting in that Car except as otherwise permitted by INDYCAR. The Car number is listed on the Entry and signifies the Car to be credited. The points and awards accumulate on behalf of the entered Car number, separately from any other Entrant's License that Team may hold.

### **10.3. Crediting of Points**

**10.3.1.** INDYCAR has established the following system under which eligible Engine Manufacturers, Entrants and Drivers may accumulate points.

**10.3.2.** Entrant points will be credited only to an Entrant holding a valid Entrant's License at the time of the Event, competing with a properly entered Car and



displaying the assigned Car number throughout any Event.

**10.3.3.** Driver points will be credited only to Drivers holding a valid Driver License at the time of the Event.

**10.3.4.** INDYCAR will not credit the point(s) usually earned by the Entrant and Driver starting a Race in the pole position if the starting field is determined in accordance with Rule 8.1.10.

**10.3.5.** If a Car participates in practice and/or qualifications but is unable to start a Race, the Driver and/or the Entrant shall receive half of the points the Car would have received for the Race had the Car started the Race ("non-starting Cars"). INDYCAR shall determine whether a Car is deemed to have participated for purposes of this Rule 10.3.5.

**10.3.6.** Unless otherwise provided by INDYCAR, all Entries shall be eligible for Entrant and Driver points associated with participation in an Event.

**10.3.7.** Entrants and Drivers displaying the mandatory award sponsors and otherwise complying with the Rules may be eligible to earn points and awards.

## **10.4. Ties**

**10.4.1.** At the close of the season, the Engine Manufacturer, Entrant and Driver with the highest number of ranking points respectively shall be declared the Champion. In the case of a tie in the championship, INDYCAR will determine the champion based on the most first place finishes. If there is still a tie, INDYCAR will determine the champion by the most second place finishes, then the most third place finishes, etc., until a champion is determined.

**10.4.2.** INDYCAR will apply the same system to other ties in the rankings at the close of the season and at any other time during the season.

## **10.5. End of Season Points Fund**

**10.5.1.** INDYCAR reserves the right to establish an end of season points fund.

## **10.6. Points**

**10.6.1.** Points may be earned by Entrants and Drivers based upon participation in Races and Qualifications and Engine Manufacturers based upon participation in Races.

**10.6.2. Entrant/Driver Race Points** – INDYCAR will award points pursuant to finishing position as follows:

<b>Race Finish Points</b>					
<b>Position</b>	<b>Points</b>	<b>Position</b>	<b>Points</b>	<b>Position</b>	<b>Points</b>
1	50	12	18	23	7
2	40	13	17	24	6
3	35	14	16	25	5
4	32	15	15	26	5
5	30	16	14	27	5
6	28	17	13	28	5
7	26	18	12	29	5
8	24	19	11	30	5
9	22	20	10	31	5
10	20	21	9	32	5
11	19	22	8	33	5
<b>Leading At Least One Lap: 1 point</b>					
<b>Most Laps Led: 2 points</b>					

### **10.6.3. Entrant/Driver Qualifications Points**

**10.6.3.1. Indianapolis 500® Mile Race** – To be issued by Bulletin.

**10.6.3.2. Double Header Race Events** – Points are awarded as follows:

**Race 1** – 1 point to the Entrant and Driver qualifying for the pole position.

**Race 2** – 1 point to the Entrant and Driver with the fastest time in each Qualifying Group.

**10.6.3.3. All Other Events** – Except as otherwise provided in Rule 10.3.5, INDYCAR shall award one point to the Entrant and Driver qualifying for the pole position.

**10.6.4. Engine changes** - To be issued by Bulletin.

**10.6.5. Engine Manufacturer Championship Points**  
- To be issued by Bulletin.

# 11. AWARDS

## 11.1. Approval

**11.1.1.** The distribution of all awards must be approved by INDYCAR.

## 11.2. Awards

**11.2.1.** INDYCAR shall determine the eligibility, nature, and amount of all for:

- a) Each Event, and
- b) End of season.

## 11.3. Withholding

**11.3.1. Offset** - INDYCAR shall have the right to offset any amounts owed by a Member to INDYCAR, an Event Promoter or a Manufacturer against any award otherwise payable to the Member or the Member's Entrant. If INDYCAR receives notice that Member has failed to pay an Event Promoter or Manufacturer, INDYCAR shall have the right to pay the Event Promoter or Manufacturer directly after giving the Member a 48 (forty-eight) hour period to dispute the offset. Should the Member dispute the offset or in the event INDYCAR receives conflicting demands for such amounts, INDYCAR shall, at its option, be entitled to seek a court order to ascertain the rightful distribution of funds.

**11.3.2. Protest** - If a protest is lodged affecting the distribution of an award, all awards so affected shall be forwarded to the INDYCAR office or in the case of

monetary awards placed in an escrow account as directed by INDYCAR within five business days after the filing of the protest, without obligation as to interest.

## 12. PROTESTS

*Please take notice that INDYCAR is in the process of revising this Section 12 (Protests). When the new Section 12 (Protests) is final, INDYCAR will distribute the new Section 12 (Protests) via Bulletin to all Members, Entrants, Teams, Drivers, Officials, and Stewards. The new Section 12 (Protests) will be effective immediately upon distribution to the Members, Entrants, Teams, Drivers, Officials and Stewards and the current Section 12 (Protests) will be automatically and immediately terminated, deleted from the Rules, and no longer effective.*

### 12.1. Submission of Protests

**12.1.1.** A protest shall be submitted to:

**Beaux Barfield (including his representative)  
Race Director  
INDYCAR  
4551 West 16th Street  
Indianapolis, IN 46222**

### 12.2. Protest

**12.2.1. Written Protest** - A protest shall be in writing clearly state the errors claimed. Each claimed error must be stated in specific rather than general terms and must be accompanied by a written statement of the facts and grounds upon which it is based. Except in the case of penalties that may not be protested or appealed as set forth in these Rules, a Member who receives a penalty notice may file a protest pursuant to this Rule 12.

**12.2.2. Protest Fee** - The protest fee is \$2,500. This fee will be refunded if a penalty or ruling is overturned. The

protest fee is in addition to any monetary penalty previously assessed. The protest fee shall not earn interest.

### **12.3. Informal Inquiry**

**12.3.1.** All Entrants or Members are encouraged to resolve any dispute informally. If a potential issue is known before the posting of the official results, affected parties may verbally request an informal inquiry which shall be conducted in any manner deemed appropriate by the Race Director. There shall be no fee payable for such informal inquiry. Once the posting occurs or the time lapse no longer permits, the provisions of Rule 12 applicable to all protests shall apply.

### **12.4. Right to Protest and Time Limits**

**12.4.1. Entry** – If an Entry is rejected, the Entrant submitting the Entry may protest the rejection of such Entry. A protest must be filed within twenty-four (24) hours of notice of rejection of the Entry. Any Competitor who competes in any Event that is not in accordance with the published Entry form conditions waives the right to protest the non-enforcement of such conditions.

**12.4.2. Entrant** - Only an Entrant may protest an action of the scoring, inspections or awards of positions or an action of the Entrant or another Competitor during an Event. The protest must be lodged within thirty (30) minutes after the official posting of results or the issuance of the penalty notice. To preserve the right to protest, the Entrant must verbally notify the Race Director of its intent to file a protest within fifteen (15) minutes after the official posting of results or the issuance of the penalty notice. If a penalty is not issued until the next Business Day or later after an Event, the

protest must be lodged by 5 p.m. E.D.T. of the second Business Day following the release of the penalty notice.

**12.4.3. Other Members** - Except as otherwise provided in the Rules, a Driver or other Member may protest any action taken by INDYCAR only with respect to such Driver or Member. Protests of actions taken by INDYCAR must be lodged within thirty (30) minutes after the official posting of results or the issuance of the penalty notice. To preserve the right to protest, the Driver or other Member must verbally notify the Race Director of the Driver's/Member's intent to file a protest within fifteen (15) minutes after the official posting of results or the issuance of the penalty notice. If a penalty is not issued until the next business Day or later after an Event, the protest must be lodged by 5 p.m. E.D.T. of the second business Day following the release of the penalty notice.

**12.4.4. Violation Involving Multiple Members** - Where more than one Member of the same Team is involved in the same violation of the Rules, one (1) protest and protest fee is necessary to cover all such Member(s). Where more than one (1) Team is involved in the same violation of the Rules, the Race Director may allow one protest and protest fee to cover all Teams similarly affected. However, in order to not lose any rights, each Team who desires to protest should timely file its individual protest and fee.

**12.4.5. Affected Member** -Any Member who is entitled to protest an issue being protested by another Member is an interested party who has the right to be heard but whose own interest will not be controlled by the protest or appeal decision unless INDYCAR chooses to provide relief. Likewise, a Member whose interest may be affected by a protest by another Member has a right to be heard at a protest hearing.



#### **12.4.6. Decisions Not Subject to Protest or Appeal -**

Members recognize the need for INDYCAR to make decisions that require judgment and the exercise of Discretion, often instantaneously with Events as they are occurring. Members recognize that there is a limited system of instant replay during or after an Event. The exercise of judgment by INDYCAR during an Event, and any other matters which may be designated as not subject to protest or appeal under these Rules, may not be protested or appealed and the decision of INDYCAR is final and binding. Examples of this exercise of judgment include, without limitation, the following:

- a)** To declare a practice session completed or to modify a practice session;
- b)** Whether a Car has participated sufficiently to be deemed a non-starting Car;
- c)** To declare or end a Yellow Condition;
- d)** When and where to move a Car;
- e)** Whether a Car must forfeit its one (1) guaranteed qualifications attempt;
- f)** To add warm up laps to a qualifications attempt, interrupt a qualifications attempt or extend qualifications;
- g)** To add Provisional Starting Cars;
- h)** To start a Race on "wet" tires;
- i)** When a Car is returned to its original starting grid position prior to the conclusion of the parade lap;
- j)** To reorder the Car at the rear of the starting grid;

- k)** Whether a Car advanced or maintained its position relative to other Cars due to an off Track excursion;
- l)** Whether a Car retiring from a Race in pit lane shall be credited with completing a lap;
- m)** Whether a Car was properly positioned upon the declaration of a Yellow Condition;
- n)** Whether the Safety Car signaled a Driver to pass during a Yellow Condition;
- o)** Whether a proper passing signal was given during a Yellow Condition;
- p)** Whether the Safety Car or another Car was improperly passed during a Yellow Condition;
- q)** Whether a Car was properly positioned as it crossed the point designated as the end of the pit lanes;
- r)** Whether the Car leading the Race or any other Car fails to restart or pace the Race as directed by INDYCAR;
- s)** Whether to declare or end a Green Condition during a Race, including declaring the abort of a Race start or restart;
- t)** Whether to declare a black flag, disqualification, or other non-monetary penalty;
- u)** Whether to reposition a Car in a posting to reflect the failure to fulfill a black flag or other penalty;
- v)** Whether a Member attempted to or engaged in unsafe behavior, unsportsmanlike behavior, blocking or Team tactics;

- w)** Whether a Car followed proper procedures entering pit lane, participating in a pit stop, or exiting pit lane;
- x)** Whether a Driver passed the Driver's pit by more than one pit and was pushed back to the pit;
- y)** Whether a Car successfully completed technical inspection;
- z)** Whether a Car involved in a crash prior to the Race may be repaired or must be replaced by a Backup Car and start at the rear of the starting grid;
- aa)** Whether a Car was in a hazardous condition or was involved in contact such that it will not be permitted to continue in an Event;
- bb)** To approve technical and structural changes during a Race;
- cc)** Whether to declare a Red Condition during a Race;
- dd)** To declare a Car was involved in a crash during or subsequent to the Red Condition;
- ee)** To restart a Race stopped by the declaration of the red condition, or to Rule a Race complete;
- ff)** Whether a Car caused an avoidable Yellow or Red Condition;
- gg)** To declare a Race completed, canceled, postponed, temporarily stopped, or delayed.

**12.4.6.1.** Notwithstanding the foregoing, INDYCAR may review a decision that is non-protestable as it deems appropriate. Review of a non-protestable

decision does not render it protestable or appealable.

**12.4.6.2.** The Race Director may decline to accept a protest, even if the matter were otherwise protestable, if he determines that the alleged Rule violation is so insubstantial as to not provide a Member with a significant competitive advantage over other Members.

## **12.5. Jurisdiction**

**12.5.1.** The Race Director shall have the exclusive jurisdiction to resolve all protests. Notwithstanding the foregoing, the Race Director shall have the right to select an individual or individuals to resolve a protest with all of the powers and responsibilities of the Race Director set forth in Rule 12. The jurisdiction of Race Director is limited to those matters and issues submitted in a timely written protest to the Race Director by the protestant. The decision which is the subject of the protest shall not be stayed pending the protest unless otherwise determined by the Race Director and upon such terms as the Race Director deems appropriate.

## **12.6. Advisory Committee**

**12.6.1.** While the Race Director has no obligation to use an advisory committee, the Race Director may choose to use an advisory committee selected by the Race Director to assist in making a determination on a protest. The members of the committee shall consist of individuals who do not have a financial interest in the outcome of the protest. The advisory committee may make a recommendation as to the disposition of the protest, but the Race Director may choose to accept, not accept or modify the recommendation.

## **12.7. Hearing of the Protest**

**12.7.1.** The Race Director may cause an investigation to be made into the matters surrounding the protest and shall convene a hearing which may be telephonic, within fourteen (14) Business Days of receipt of the protest unless the hearing date is extended by the mutual agreement of the Race Director and the protestant. The protestant and any Member requesting an opportunity to participate and who the Race Director determines has a material interest in the proceeding shall be given notice of the hearing and shall be entitled to be heard and given an opportunity to call witnesses. The effect on championship point standings does not constitute a "material interest". It is the Race Director's decision as to whether to permit a Member to be represented by counsel at the hearing.

## **12.8. Conduct of the Protest Hearing**

**12.8.1.** The hearing will be conducted according to the following procedures:

**12.8.1.1.** The hearing is not open to the public and admittance to the hearing is only by invitation of the Race Director and can be revoked at any time. The Race Director shall conduct the hearing in an informal manner. The hearing shall be confined to the errors claimed in the protest and evidence relevant to those errors.

**12.8.1.2.** The Race Director shall identify the parties and other necessary participants in the proceedings. The Race Director may summon any Member to testify at the hearing. If a Member is called as a witness and fails to appear, INDYCAR may revoke the Member's membership or otherwise penalize the Member.

**12.8.1.3.** The Race Director shall not be limited to the technical common law Rules of evidence required in judicial proceedings but shall be satisfied the evidence submitted is of a type on which the Race Director can rely.

**12.8.1.4.** All parties to the proceedings shall be permitted to present and cross-examine witnesses and to submit evidence, both oral and documentary. The burden of proof shall remain at all times on the protestant.

**12.8.1.5.** Consistent with the informal nature of the protest hearing, there shall be no transcript of the hearing unless the Race Director determines otherwise.

**12.8.1.6.** The Race Director is not required to consider matters not assigned as error in the original protest or matters outside the scope of the submission by the protestant.

## **12.9. Unusual Circumstances**

**12.9.1.** The Race Director shall have the right to require the protestant to post an adequate bond to cover the costs of the protest or any reasonable foreseeable economic harm to INDYCAR or other Members that might be caused by the protest. If the Race Director requires a bond, its form and substance shall be in the Discretion of the Race Director.

## **12.10. Determination of the Protest**

**12.10.1.** There is no deadline for the issuance of a decision by the Race Director and the decision may be oral or written, as determined by the Race Director. The time frame will depend upon the nature of the protest. It

is anticipated that a decision will normally be issued within fourteen (14) Business Days

### **12.11. Protest Procedure Final**

**12.11.1.** The decision of the Race Director on the protest shall be final and binding on all Members, subject only to the right to appeal the decision under the Rules. Any award withheld as a result of a protest shall continue to be withheld until the protest has been finally adjudicated in accordance with the Rules. Any monetary awards held will not earn interest.

### **12.12. Compliance with Procedures**

**12.12.1.** Any protest that fails to comply with any of the foregoing requirements may be dismissed and disregarded. Any error not specifically raised in the protest shall be deemed to have been waived.

## 13. APPEALS

*Please take notice that INDYCAR is in the process of revising this Section 13 (Appeals). When the new Section 13 (Appeals) is final, INDYCAR will distribute the new Section 13 (Appeals) via Bulletin to all Members, Entrants, Teams, Drivers, Officials and Stewards. The new Section 13 (Appeals) will be effective immediately upon distribution to the Members, Entrants, Teams, Drivers, Officials and Stewards and the current Section 13 (Appeals) will be automatically and immediately terminated, deleted from the Rules, and no longer effective.*

### 13.1. Submission of Appeals

**13.1.1.** – An appeal shall be submitted to:

**Brian Barnhart (including his representative)**  
**Vice President of Competition**  
**INDYCAR**  
**4551 West 16th Street**  
**Indianapolis, IN 46222**

### 13.2. Appeal

**13.2.1.** An appeal is intended to be formal as compared to the informal protest process and includes, without limitation:

**13.2.2. Written Appeal** - The appeal must be in writing and must contain reference to the specific action by INDYCAR from which an appeal is taken, the date of the occurrence, the reasons for the appeal, and specific reference to any Rules allegedly violated and the relief requested. The appeal must be accompanied by copies of all written documents pertaining to the appeal, such



as protests, responses, rulings, declarations, etc. The appeal must clearly and explicitly state the basis of the appeal.

**13.2.3. Appeal Fee** - The appeal fee is \$5,000. This fee will be refunded if a penalty or ruling is completely overturned. The appeal fee is in addition to the protest fee and any monetary penalty previously assessed. The appeal fee shall not earn interest.

### **13.3. Right to Appeal and Time Limits**

**13.3.1.** To the extent permitted under the Rules, any Member may appeal a determination on a protest.

**13.3.2.** An appeal may be initiated by submitting the appeal by 5 p.m. E.D.T. of the second Business Day following the release of the protest decision.

**13.3.3. Violation Involving Multiple Members** - Where more than one Member of the same Team is involved in the same violation of the Rules, one (1) written appeal and appeal fee is necessary to cover all such Members. Where more than one Team is involved in the same violation of the Rules, the Appeal Official may allow one appeal and appeal fee to cover all teams similarly affected. However, in order to not lose any rights, each team who desires to appeal should timely file its individual appeal and fee.

**13.3.4. Affected Member** - Any Member who is entitled to appeal an issue being appealed by another Member is an interested party who has the right to be heard but whose own interest will not be controlled by the decision unless INDYCAR chooses to provide relief. Likewise, a Member whose interest may be affected by an appeal by

another Member has a right to be heard at an appeal hearing.

### **13.4. Jurisdiction**

**13.4.1.** The Appeal Official shall have the exclusive jurisdiction to resolve all appeals. Notwithstanding the foregoing, the Appeal Official shall have the right to select an individual or individuals to resolve an appeal with all of the powers and responsibilities of the Appeal Official set forth in Rule 13. The jurisdiction of the Appeal Official is limited to those matters and issues that were part of the protest and were submitted in the appellant's written appeal. The decision which is the subject of the appeal shall not be stayed pending the appeal unless otherwise determined by the Appeal Official and upon such terms as the Appeal Official deems appropriate.

### **13.5. Advisory Committee**

**13.5.1.** While the Appeal Official has no obligation to use an advisory committee, the Appeal Official may choose to use an advisory committee selected by the Appeal Official to assist in making a determination on an appeal. The members of the committee shall consist of individuals who do not have a financial interest in the outcome of the appeal. The advisory committee may make a recommendation as to the disposition of the appeal, but the Appeal Official may choose to accept, not accept or modify the recommendation.

### **13.6. Hearing of the Appeal**

**13.6.1.** The Appeal Official shall convene a hearing within thirty (30) Business Days of receipt of the appeal unless the hearing date is extended by the mutual agreement of the Appeal Official and the appellant. The appellant

and any Members requesting an opportunity to participate in the proceeding and which the Appeal Official determines to have a material interest in the proceeding shall be given written notice of the hearing and shall be entitled to be heard and call witnesses. The effect on championship point standings does not constitute a "material interest". It is the Appeal Official's decision as to whether to may permit a Member to be represented by counsel at a hearing.

### **13.7. Conduct of the Appeal Hearing**

**13.7.1.** The hearing will be conducted according to the following procedures:

**13.7.2.** The hearing is not open to the public and admittance to the hearing is only by invitation of the Appeal Official and can be revoked. The Appeal Official shall conduct the hearing consistent with a more formal proceeding than expected in the protest hearing. The hearing shall be confined to the items subject to protest and errors claimed in the appeal and evidence relevant to those errors.

**13.7.3.** The Appeal Official shall identify the parties and other necessary participants in the proceedings. The Appeal Official may summon any Member to testify at the hearing. If a Member is called as a witness and fails to appear, INDYCAR may revoke the Member's membership or otherwise penalize the Member.

**13.7.4.** The Appeal Official shall not be limited to the technical common law rules of evidence required in judicial proceedings but shall be satisfied the evidence submitted is of a type on which the Appeal Official can rely. For example, hearsay is permitted. The Appeal Official may exclude irrelevant, immaterial, or unduly repetitious evidence.

**13.7.5.** All parties to the proceedings shall be permitted to present and cross-examine witnesses and to submit evidence, both oral and documentary. The burden of proof shall remain at all times on the appellant.

## **13.8. Structure of the Appeal Hearing**

**13.8.1.** The Appeal Official shall conduct the hearing in the following manner. Prior to opening statements or the submission of proof by the appellant, the Appeal Official may request that Race Director submit an explanation of the basis of his decision.

**13.8.2. Opening Statements** - The parties to the proceedings will be permitted to make opening statements, with the appellant making the first opening statement. Each party shall state the issue(s) before the Appeal Official and a brief summary of the position of the party with respect to such issue(s).

**13.8.3. Order of Proof** - The evidence shall be received by the Appeal Official in the following order:

**13.8.3.1.** The appellant shall first submit and present evidence in support of the appeal. Upon the completion of direct examination, each witness shall be subject to cross-examination by the other parties and by the Appeal Official.

**13.8.3.2.** The Race Director and the other parties shall then be permitted to present evidence, and any witnesses presented shall be subject to cross-examination by the appellant, by other parties, and by the Appeal Official.

**13.8.4. Closing Arguments** - Upon completion of the evidentiary portion of the hearing, all parties, beginning with the appellant, may make closing arguments.

**13.8.5. Modifications** - The Appeal Official may change the hearing process upon notice to the parties.

### **13.9. Powers of the Appeal Official**

**13.9.1.** The Appeal Official shall have the following powers:

- a)** To receive and rule upon relevant evidence;
- b)** To ask questions of witnesses or the parties;
- c)** To regulate the course of the hearing;
- d)** To include or exclude individuals from the hearing;
- e)** To require the presence of witnesses;
- f)** To strike and disregard all testimony of witnesses refusing to answer proper questions;
- g)** To dispose of procedural requests, motions or similar matters;
- h)** To require a party at any time to state its position concerning any issue in the appeal or its theory in support thereof;
- i)** To impose any other requirement necessary to render a timely decision; and
- j)** To require the appellant to post an adequate bond to cover the costs of the appeal or any reasonable foreseeable economic harm to INDYCAR or other Members that might be caused by the appeal. If the Appeal Official requires a bond, its form and substance shall be at the determination by the Appeal Official.

## **13.10. Determination of the Appeal**

**13.10.1.** There is no deadline for the issuance of a decision by the Appeal Official. The time frame will depend upon the nature of the appeal. The decision may be oral or written. It is anticipated that a decision will normally be issued within thirty (30) Business Days after the conclusion of the hearing.

## **13.11. Appeal Procedure Final**

**13.11.1.** Decisions of INDYCAR shall be final and binding unless such decisions and penalties may be protestable under the Rules, are protested, and appealed within the time limitations and other procedures prescribed by the Rules, and such protests or appeals are pending.

**13.11.2.** By submitting a membership application and in consideration of receiving the numerous benefits available, each Member agrees that the final decisions of INDYCAR are non-litigable. Each Member agrees to abide by the non-appealable decisions of INDYCAR and by the final resolution in the protest and appeal procedure as to decisions that are appealable.

**13.11.3.** A Member's exclusive right to contest a decision or the Rules is within the protest and appeal procedure of INDYCAR, and any decision reached within this procedure is final and binding.

**13.11.4.** Any unappealed protest decision by the Race Director or any appeal decision by the Appeal Official on these or any other matters shall be final and binding.

**13.11.5.** No court action of any kind may be taken by any Member.

**13.11.6.** Any Member participating in an Event waives any rights such Member may otherwise have to be a party or to take any action in court seeking legal or equitable relief against any decision or action of any kind by INDYCAR, its Officials or anyone acting on behalf of INDYCAR.

**13.11.7.** Each Member acknowledges that participation in an Event by other Entrants, Drivers, and Members is in part in reliance on this waiver.

**13.11.8.** If a Member initiates or participates in litigation in violation of the Rules, all membership privileges shall thereupon be suspended and is subject to the provisions of Rule 2.8 and such Member initiating the litigation in violation of the Rules shall pay INDYCAR for all costs and expenses, and attorney's fees incurred in defending the litigation

### **13.12. Compliance with Procedures**

**13.12.1.** Any appeal that fails to comply with any of the foregoing requirements may be dismissed and disregarded. Any error not specifically raised in the protest or appeal shall be deemed to have been waived.

## **14. TECHNICAL SPECIFICATIONS**

### **14.1. General**

**14.1.1.** The only binding means of communication shall be in writing.

**14.1.2.** INDYCAR shall maintain a technical site on INDYCAR Information System (IRIS) for Members to submit questions, to provide technical information or provide various technical updates when necessary.

**14.1.3.** Questions submitted by close of business on Friday will be answered by the close of business the following Wednesday. Modifications must be approved seven (7) days prior to the date of intended use. Safety and critical issues will be answered as soon as practical.

**14.1.4.** All parts provided by an approved supplier must be used as supplied unless otherwise stated in these Rules or in update bulletins.

**14.1.5.** All original Manufacturer identification markings and/or tags must remain as supplied. Visible identification markings may be removed from parts fitted with RFID tags from Dallara.

**14.1.6.** No form of heating may be used on a Car when the Car is outside its assigned garage.

**14.1.7.** The following forms of cooling are permitted outside the assigned garage:

- a)** Cooling towels applied to bodywork;



- b)** Driver cooling fans; and
- c)** Brake cooling fans (in assigned pit box only)

**14.1.8.** Tape is not permitted as a single source of attachment for any component.

## **14.2. Technical Inspection**

**14.2.1.** The responsibility remains with the Entrants to make sure Cars conform to all Rules throughout the course of an Event.

**14.2.2.** Technical passport as supplied by Dallara must be submitted to technical inspection at the start of any on-Track Event for the chassis entered.

### **14.2.3. Reference planes and '0' coordinates**

**14.2.3.1.** All measurements shall be taken from the reference plane or '0' coordinates. These shall be established by Dallara and cannot be modified.

**14.2.3.2.** References will be measured using the following coordinates:

- a)** "X" coordinate is defined as the relative location fore and aft of the front face of the forward chassis bulkhead - "0" being the forward face of the chassis. These measurements will be referred to as +/- the "X" line, with - (negative) being forward.
- b)** "Y" coordinate is defined as the location laterally from the chassis centerline, Driver's right hand side being positive.

- c) "Z" coordinate is defined as the location vertically with the bottom of the skid being 0 'Z', + (positive) being up.

**14.2.3.3.** The bottom of the skid establishes the "chassis reference plane." For purposes of technical inspection, the "chassis reference plane will be four hard points 0.079 inches thick (2.0mm) each manufactured from steel bolted to the bottom of the chassis in the Dallara specified locations. These hard points shall be  $\varnothing$ 1.500 inches.

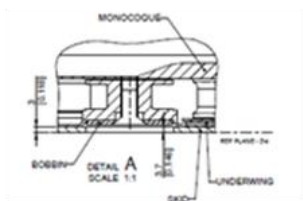
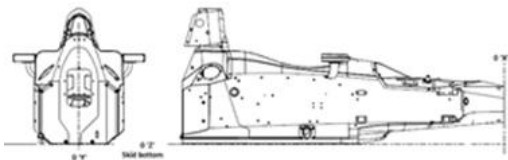

**14.2.4.** INDYCAR may impound or confiscate a Car, part, equipment, item, or data associated with a Car at any time. INDYCAR is not responsible for damage or loss as a result of inspection procedures, impounding, or confiscation.

**14.2.5.** INDYCAR may examine any Car involved in a crash and determine if it is suitable for further participation, and all Members shall cooperate in the preparation of damage reports, photographs, videotaping, and impact recording analysis.

**14.2.6.** Wheels must be inspected prior to Spring Training and prior to the Houston Event.

**14.2.7.** The original of all required chassis-repair forms must be submitted to INDYCAR for approval prior to the Car participating in the next Event.

**14.2.8.** Chassis, nose, and attenuator structural repairs may only be made by Dallara.

**14.2.9.** Nickel, chrome, or decorative platings are not permitted on parts that require magnetic inspection. All parts which are painted, plated, or have special coatings must be stripped prior to nondestructive testing and inspection.

**14.2.10.** A copy of all required INDYCAR inspection forms must be submitted to INDYCAR for approval before the designated on-Track Events.

**14.2.10.1.** All parts indicated on any INDYCAR inspection forms or in an INDYCAR bulletin must be tested by the appropriate nondestructive testing techniques or as otherwise directed by INDYCAR. These inspections shall be performed by an INDYCAR-approved inspection station prior to Spring Training and prior to the Houston Event. INDYCAR may require additional inspections during the racing season.

**14.2.11.** Water pipes must be used as supplied by Dallara.

**14.2.12.** Oil pipes are free but must have a six (6) inch flexible section at the radiator end of the pipe.

**14.2.13.** Hoses/fittings/nuts and bolts may be individually sourced by the Entrants.

**14.2.14.** Oil/greases are free.

**14.2.15.** Heat shielding other than fabrics or sleeving must be approved by INDYCAR.

**14.2.16.** After a crash during a Test, an Entrant must present the following items to INDYCAR, upon request:

- a) Driver's Helmet
- b) Driver's Head Restraint System
- c) Driver's Seat
- d) Chassis Headrest
- e) Steering Wheel
- f) Ear Pieces

INDYCAR will inspect the items. Any item that does not successfully complete inspection must be repaired, re-certified or replaced by the Entrant at the Entrant's cost prior to use.

### **14.3. Car Weight and Driver Equivalency Weight**

#### **14.3.1. Car Weight**

**14.3.1.1.** The minimum weight shall include all lubricants, coolants and camera or dummy camera housings. Fuel, Driver and the Driver equivalency weight are excluded.

**14.3.1.1.1.** Minimum weight for Road/Streets & Short Ovals – will be 1600 pounds.

**14.3.1.1.2.** Minimum weight for Speedways – will be 1570 pounds

**14.3.1.2. Ballast** - All ballast must be securely fastened, approved by INDYCAR, and declared at technical inspection. The only two (2) approved ballast locations are keel and skids.

**14.3.2. Driver Equivalency Weight** – INDYCAR shall determine the additional Driver Equivalency Weight required and shall notify each Entrant by bulletin. The Driver Equivalency Weight must be installed and secured in the designed location forward of the seatback as per the following illustration. The Driver Equivalency Weight must be a hard dense metal. Violation of this Rule 14.3.2 may result in a minimum \$100,000 monetary fine and/or such other penalties as INDYCAR shall deem appropriate.

**14.3.2.1.** Driver Equivalency Weight will be required to bring the combined weight of Driver and driver ballast to 185lbs. The Driver ballast weight tolerance is - 0 to + 1.00lbs. INDYCAR reserves the right to weigh any Driver at any time and adjust driver ballast accordingly.

**14.3.2.2.** In addition to the location specified in Rule 14.3.2, a 10lb (tolerance - 0 to + 0.50lbs) driver ballast weight may be added to the front face of the pedal bulkhead as per approved drawing supplied by Dallara. This location may only be used for driver ballast; only Drivers required to run 10lbs or more ballast may use this location.

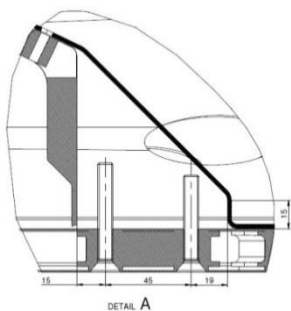
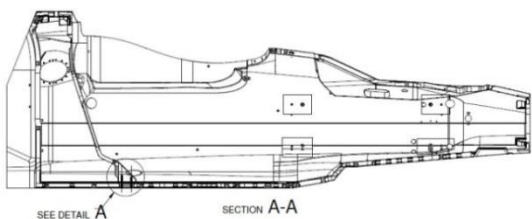

## 14.4. Chassis

**14.4.1. Timing Transponder** – The timing transponder as supplied by INDYCAR must be used at all times. The cover supplied by Dallara must remain in place.

**14.4.2. On Board Fire Equipment** - Each Car must have the Dallara supplied built-in operable fire extinguishing equipment with a minimum content of 2.250 liters in the Dallara/INDYCAR specified location. The U.S. Department of Transportation approved fire suppressant must be AFFF-M-E fluid.

**14.4.3. Impact Recorders** - All Cars must make provisions for the installation of an impact recorder.

**14.4.3.1.** The impact recorder supplied by INDYCAR and used without modification, must be securely bolted using 4 bolts to the main chassis structure in the Dallara/INDYCAR specified location.

**14.4.3.2.** The impact recorder download block and indicator lights must be located in the Dallara/INDYCAR specified location.

**14.4.4. Mirrors Lens** - The minimum mirror glass dimension is 6.000 inches wide by 2.000 inches tall with a corner radius of 0.375 inches. No portion of the mirror lens may be recessed in the mirror housing by more than 0.250 inches. The standard Dallara mounting location for the lens must not be moved and the housing must be trimmed to respect the 0.250-inch dimension.

**14.4.4.1.** The top of the mirror housing must be between 0 degrees to +7 degrees (nose down) in the longitudinal axis.

**14.4.5. Cockpit** – Cars must have fitted all the Dallara supplied cockpit panels and EPP foam panels in the footbox, leg and seat area. No modifications can be made without prior INDYCAR approval.

**14.4.6. Windscreen** – All windscreens must be approved by INDYCAR prior to use.

#### **14.4.7. Seating System**

**14.4.7.1.** Each seat must be manufactured for a specific Driver. Each seat must have a unique identification tag from the seat manufacturer and be date stamped. All seats must be inspected and approved by INDYCAR before use and will be subject to re-inspection by INDYCAR at any time. INDYCAR may require a seat to be replaced.

**14.4.7.2.** The Driver's seat must conform to the Driver's anatomy and be constructed of an INDYCAR- approved material that will permit support and energy-attenuation both laterally and rearward. This material must fill as much of the cockpit under, behind and to the side of the Driver as possible. The seating system must be in place when the Car is inspected.

**14.4.7.3.** When the Driver is seated, there must be a smooth transition of energy-attenuating materials between the top of the seat and the cockpit rim padding, including the rear headrest. There must be no projections that could provide a fulcrum between the Driver's head and neck.

**14.4.8. Seat Belts** - An approved seat belt with a quick-release mechanism must be used. Both the fastening design and condition of the belt is subject to inspection by INDYCAR. Life of the belts in use shall not exceed 2 years and must be date-stamped by the manufacturer. All belts must conform to the following SFI specifications: 3 inch SFI 16.1, 2 inch SFI 16.5 or equivalent specification as approved by INDYCAR.

**14.4.8.1.** Seat belts must be worn in such a manner that they are tight and pass around the pelvis at a point below the anterior superior iliac spines.

**14.4.8.2.** Seat belts may not pass over the sides of the seat. They must come through the seat at the bottom on each side thereby wrapping and holding the pelvis over the greatest possible area.

**14.4.8.3.** 6-point (crotch) belts must be connected to the main belt quick-release mechanism and securely attached to the chassis.



**14.4.8.4.** Seat belts which have had to withstand a crash in excess of fifty (50) Gs must be replaced.

**14.4.9. Shoulder Harness** – Double over-the-shoulder straps must be used. HANS® specific double-shoulder belts are permitted, provided they are mounted and used according to manufacturer specifications. Both the fastening design and condition of the straps is subject to inspection by INDYCAR. Life of the straps in use shall not exceed two (2) years and must be date-stamped by the manufacturer. Belts should be attached in a line approximately ninety (90) degrees to the seat back and be approximately level with the top of the Driver's shoulders or at a slightly downward angle.

**14.4.9.1.** Mounting of all belts must use the manufacturer supplied mount and use the supplied mounting positions unless otherwise approved by INDYCAR.

**14.4.10. Headrest** -Headrests must be used as supplied by Dallara.

**14.4.10.1.** All headrests must be inspected and approved by INDYCAR before use and will be subject to confiscation and re-inspection by Officials at any time. INDYCAR shall affix stickers to the headrests signifying approval for use. At any time, Officials may remove the approval stickers and require the headrests to be re-inspected and refurbished by Dallara before INDYCAR may consider them for re-approval.

**14.4.10.2.** Headrests must be attached by the Dallara supplied mechanism. The headrest clip must be Dallara part IR1201B021. The headrest must be in place during technical inspection.

**14.4.11. Additional Headrest Padding** – Additional side padding must not exceed the height of the stock headrest as viewed from the side. Additional rear padding must not exceed the height or width of the headrest as viewed from the front. All padding must be contained in the original headrest dimensions as looked at in plan view.

The additional headrest padding if used must consist of separate pieces; left side, right side and/or rear. The side pieces are restricted to 15.000 inches in overall length and must have a minimum 3.000 inch leading edge taper from the front edge when viewed from the top (plan view).

The additional padding must be removable independently of each other without the use of tools. All additional padding must be manufactured completely of foam, each piece may have a single layer Kevlar backing to assist in the mounting providing that it remains flexible and does not interfere with the original function of the stock headrest.

Any covering used on the additional padding must remain flexible and be approved by INDYCAR. Additional padding may not be taped along any surface. All additional pads and coverings must be inspected and approved by INDYCAR prior to use.

**14.4.12. Roll Hoop** – The Drivers helmet must be a minimum of 7.000 inches below the chassis mounting face of the roll hoop camera. **(See Illustration).**

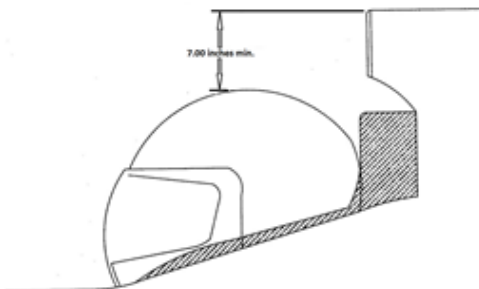

#### **14.4.13. Car Tracking System, Telemetry and In-Car Cameras**

**14.4.13.1. Car Tracking System** – The INDYCAR-approved car tracking system must be installed in the designated location(s) on each Car and must be operational at any time the Car is participating in on-Track Events unless otherwise notified by INDYCAR.

**14.4.13.2. Telemetry** - INDYCAR shall own any and all telemetry, video, sound, data or other information generated or collected. The use and control of the dissemination of the telemetry, video, sound, data or other information shall be determined by INDYCAR.

**14.4.13.3. In-Car Cameras** – As requested by INDYCAR, each Car must use either the cameras or dummy equipment as supplied by Broadcast Sports Inc. (BSI)/INDYCAR.

**14.4.13.4.** Entries are permitted to use their own on board video equipment, provided it is used during practice only and pre-approved by INDYCAR.

## 14.5. Dimensions

### 14.5.1. Length

#### 14.5.1.1. Road & Street Courses / Short Ovals -

The overall length of the Car is 203.94 inches +/- 0.250 inches.

#### 14.5.1.2. Speedways – The overall length of the Car

is 197.335 inches +/- 0.250 inches.

### 14.5.2. Wheelbase

**14.5.2.1.** The maximum wheelbase is 121.500 inches and minimum is 117.500 inches.

**14.5.2.2.** The wheelbase of the Car, left to right, may have a maximum variance of 0.750 inch.

### 14.5.3. Track Width (measured at axle center line)

**14.5.3.1.** Shimming of the inboard suspension mounting blocks is permitted to achieve maximum track width tolerances within the Rules.

**14.5.3.2. Ovals** – Front and rear are limited to a minimum of 75.750 inches and a maximum of 76.750 inches.

**14.5.3.3. Road & Street Courses** - Front and rear are limited to a minimum of 75.500 inches and a maximum of 76.500 inches.

### 14.5.4. Track Width Offset

**14.5.4.1. Ovals** – The Car can be between 0.150 inches off center to the left or 0.600 inch off center to the right.

**14.5.4.2. Road & Street Courses** – A maximum of +/- 0.250 inches is permitted left or right of center.

## **14.6. Aerodynamics**

**14.6.1.** Attachments or devices that are movable or adjustable while the Car is in motion and which may affect airflow or aerodynamics are not permitted.

**14.6.2. Wickers** - Wickers are permitted in the following places (see illustrations) and have the following restrictions:

### **14.6.2.1. All Events**

- a) Maximum height of 1.000 inches;
- b) Maximum mounting face 0.750 inches long;
- c) Securely fixed with a minimum of 3 mechanical fasteners if greater than 6.000 inches in length;
- d) Wickers less than 6.000 inches must have a minimum of 2 mechanical fasteners;
- e) Must be at 90 degrees to the mounting surface;
- f) Must be rigid with a minimum thickness of 0.043 inches;
- g) Must be parallel, stepped or tapered in profile with no sharp corners.

### 14.6.2.2. Road/Street Courses/Short Ovals

- a) Must be mounted on the top surface of wing elements at the trailing edge;
- b) Rear wing end fence wickers are only permitted on Road/Street Courses.
- c) The front end plate wicker (Dallara Part #IR12-04B023) may be trimmed to increase brake cooling.

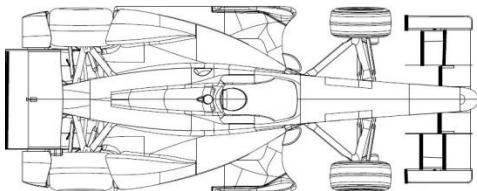
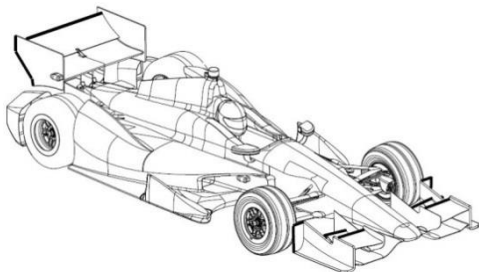

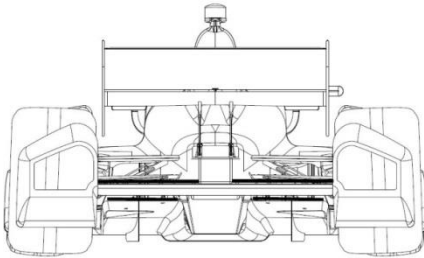

### 14.6.2.3. Indianapolis 500® Mile Race and Speedways

- a) Must be mounted on the top surface of wing elements at the trailing edge, with the exception of Rule 14.6.2.3.b;
- b) A single reverse wicker may be mounted on the bottom outboard trailing edge of the front wing with a maximum length of 6.000 inches.

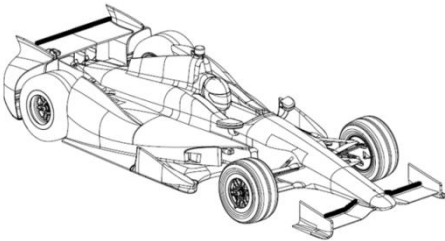

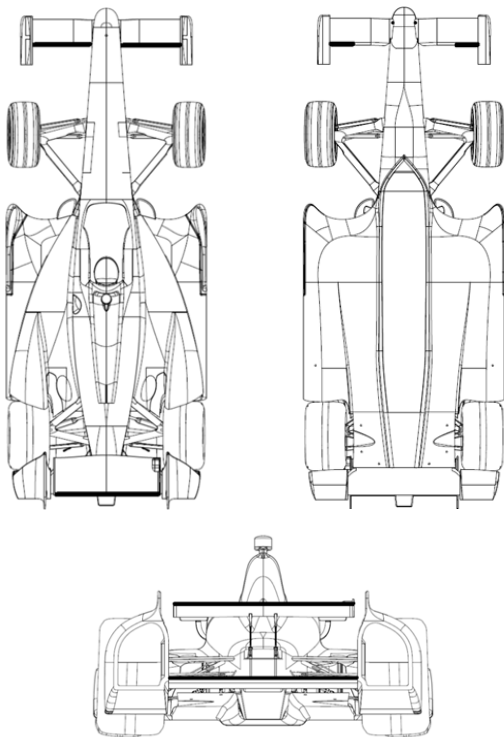

### 14.6.3. Front Wings

#### All Events

**14.6.3.1.** The complete front wing assembly must be used as supplied without modification and used in the configuration designated by INDYCAR.



- 14.6.3.2.** No painting, adhesive film, or any other substance may be added to the lower wing surface from a point 2 inches behind the leading edge of the wing to the trailing edge of the wing.
- 14.6.3.3.** The trailing edge thickness of the front wing mainplane and flaps must be 0.075 inches plus 0.050 inches or minus 0.025 inches.
- 14.6.3.4.** The overall thickness of the end fence is 0.800 inches plus or minus 0.050 inches.
- 14.6.3.5.** Shimming of the front wing is permitted to achieve heights, set back, and wing angle within the Rules.

### **Road / Street & Short Ovals**

- 14.6.3.6.** The maximum overall width of the mainplane is 59.100 inches and minimum of 58.800 inches.
- 14.6.3.7.** The bottom surface of the wing shall be no less than 2.700 inches above the chassis reference plane.
- 14.6.3.8.** The maximum amount of front wing deflection will be 0.300 inches with a suspended load of 75 pounds applied at each outer end of the front wing end fences.
- 14.6.3.9.** The lower flap width is 14.910 inches plus or minus 0.050 inches.
- 14.6.3.10.** The upper flap width is 14.930 inches, plus or minus 0.050 inches.

**14.6.3.11.** The width of the end fence foot is 6.000 inches plus or minus 0.050 inches.

### **Indianapolis 500® Mile Race and Speedways**

**14.6.3.12.** The overall width of the mainplane is maximum of 58.350 inches and minimum of 58.050 inches.

**14.6.3.13.** The bottom surface of the wing shall be no less than 4.400 inches above the chassis reference plane.

**14.6.3.14.** The front wing deflection allowed will be 0.425 inches with a suspended load of 75 pounds applied at each outer end of the front wing end fences.

**14.6.3.15.** The width of the end fence foot is 4.870 inches plus or minus 0.050 inches.

**14.6.3.16.** The bottom edge of the end fences must be a minimum of 2.550 inches above the chassis reference plane.

### **14.6.4. Rear Wing**

#### **All Events**

**14.6.4.1.** The complete rear wing assembly must be used as supplied without modification and used in the configuration designated by INDYCAR.

**14.6.4.2.** The overall width of the mainplane is 41.720 inches plus or minus 0.050 inches.

- 14.6.4.3.** Shimming of the rear wing is permitted to achieve heights, set back, and wing angle within the Rules.
- 14.6.4.4.** The rear beam wing angle is 0.00 deg. plus or minus 0.500 deg.
- 14.6.4.5.** The rear wheel pod angle is 90 degrees plus or minus 1.00 degree in the "X", "Z" plane and the "Y", "Z" plane.
- 14.6.4.6.** The rear beam wing angle is 0.00 deg. plus or minus 0.500 deg. Shimming of the rear beam wing is permitted to achieve angle within the Rules.
- 14.6.4.7.** The trailing edge thickness of the rear wing mainplane and flaps must be 0.080 inches plus 0.050 inches minus 0.025 inches.
- 14.6.4.8.** The top surface of the mainplane must be covered with an INDYCAR-approved wrap. The mainplane wrap must be used as supplied and start at the trailing edge. The mainplane wrap may have printing and decals applied, providing the printing or decals are approved by INDYCAR prior to use.
- 14.6.4.9.** One 2.000 inch strip of helitape may be placed along the leading edge of the mainplane, provided it is applied 1.000 inch below and 1.000 inch above the centerline of the leading edge of the mainplane.
- 14.6.4.10.** During initial technical inspection at each Open Test and Race Event, the rear wing must be presented without the mainplane wrap.

**14.6.4.11.** No part of the rear wing mainplane may extend rearward of the differential axle centerline more than 26.188 inches.

**14.6.4.12.** The top edge of the end fence must be parallel to the chassis reference plane, plus or minus 0.250 deg.

**14.6.4.13.** The maximum amount of rear wing mainplane deflection will be advised by bulletin.

### **Road / Street Courses & Short Ovals**

**14.6.4.14.** The maximum amount of rear flap deflection will be advised by bulletin.

**14.6.4.15.** The overall width of the flap is 41.700 inches plus or minus 0.050 inches.

**14.6.4.16.** The rear wing mainplane must be set at 0.0 deg +/- 0.50 deg.

**14.6.4.17.** Flap must be covered with an INDYCAR-approved wrap. It may have printing and decals applied, providing the printing or decals are approved by INDYCAR prior to use. One 2.000 inch strip of helitape may be placed along the leading edge of the flap provided it is applied 1.000 inch below and 1.000 inch above the centerline of the leading edge of the flap.

**14.6.4.18.** The mainplane trailing edge height, as measured from the chassis reference plane is 28.060 inches plus or minus 0.050 inches.

**14.6.4.19.** The overall thickness of the end fence is 0.430 inches plus or minus 0.050 inches.

**14.6.4.20.** Rear wing slot gap - The flap angles are in degrees. The slot gaps are in inches.

<b>Top Flap Angle</b>	<b>Min.</b>	<b>Std.</b>	<b>Max.</b>
10	0.250	0.359	0.389
36	0.300	0.412	0.442
38	0.300	0.408	0.440

### **Speedways**

**14.6.4.21.** The mainplane trailing edge height, as measured from the chassis reference plane is 27.960 - 28.210 inches.

**14.6.4.22.** No part of the rear wing end fences may extend rearward of the differential/spool centerline more than 31.188 inches.

**14.6.4.23.** The overall thickness of the end fence is 0.430 inches plus or minus 0.050 inches.

## **14.6.5. Race Location Specific Configurations**

### **14.6.5.1. Indianapolis 500® Mile Race**

#### **14.6.5.1.1. Mandatory Parts:**

- a) Rear Mainplane,  $0 > -10.5$  degrees  
IR1205B001
- b) Rear Mainplane Profile  
IR1205B011(RH)  
IR1205B012(LH)
- c) Rear Indy Wheel Guard  
IR1205A019/20

#### **14.6.5.1.2. Optional Parts:**

- a) Side Wall - IR1203A007/8
- b) Trimmed Side Wall - IR1203A007/8
- c) Rear Wheel Backing Plate  
IR1210H001 - 011
- d) Sidepod Top Infill  
IR1202A031/32
- e) 2/3 Radiator Inlet Shutter  
IR1202A029/30
- f) Rear Wing Wicker

#### **14.6.5.1.3. Unapproved Parts:**

- a) Underwing Strake  
IR1203A003/4

## **14.6.5.2. Texas**

### **14.6.5.2.1. Mandatory Parts:**

- a)** Rear Mainplane, IR1205B001 (angle to be confirmed by Bulletin)
- b)** Rear Mainplane Profile  
IR1227227 - IR1205B011(RH)  
IR1227224 - IR1205B012(LH)
- c)** Rear Indy Wheel Guard  
IR1205A019/20

### **14.6.5.2.2. Optional Parts:**

- a)** Rear Wheel Backing Plate  
IR1210H001 - 011
- b)** Sidepod Top Infill - IR1202A031/32
- c)** 2/3 Radiator Inlet Shutter  
IR1202A029/30

### **14.6.5.2.3. Unapproved Parts:**

- a)** Underwing Strakes - IR1203A003/4
- b)** Side Wall - IR1203A007/8
- c)** Trimmed Side Wall - IR1203A007/8
- d)** Rear Wing Wicker

### **14.6.5.3. Milwaukee**

#### **14.6.5.3.1. Mandatory Parts:**

- a) Road/Street Course Mainplane  
IR1205B001
- b) Standard Rear Wheel Guard  
IR1205A003  
IR1205A004
- c) Underwing Strake - IR1203A003/4
- d) Side Wall - IR1203A007/8
- e) SWY Front Brake Backing Plate  
IR1210E001/2

#### **14.6.5.3.2. Optional Parts:**

- a) 2/3 Radiator Inlet Shutter  
IR1202A029/30
- b) Rear Wing Wicker

#### **14.6.5.3.3. Unapproved Parts:**

- a) Rear Wheel Backing Plate  
IR1210H001 - 011
- b) Sidepod Top Infill - IR1202A031/32
- c) Trimmed Side Wall - IR1203A007/8
- d) Rear Wing End Plate Wickers



#### **14.6.5.4. Iowa**

##### **14.6.5.4.1. Mandatory Parts:**

- a) Road/Street Course Mainplane  
IR1205B001
- b) Rear Flap 34.00 degrees maximum  
IR1205C002
- c) Standard Rear Wheel Guard  
IR1205A003 / IR1205A004
- d) Underwing Strake - IR1203A003/4
- e) Side Wall - IR1203A007/8
- f) SWY Front Brake Backing Plate  
IR1210E001/2

##### **14.6.5.4.2. Optional Parts:**

- a) 2/3 Radiator Inlet Shutter  
IR1202A029/30
- b) Rear Wing Wicker

##### **14.6.5.4.3. Unapproved Parts:**

- a) Rear Wheel Backing Plate  
IR1210H001 - 011
- b) Sidepod Top Infill - IR1202A031/32
- c) Trimmed Side Wall - IR1203A007/8
- d) Rear Wing End Plate Wickers

## **14.6.5.5. Pocono**

### **14.6.5.5.1. Mandatory Parts:**

- a)** Rear Mainplane,  $0 >$  minus 10.5 degrees  
IR1205B001
- b)** Rear Mainplane Profile  
IR1205B011(RH)  
IR1205B012(LH)
- c)** Rear Indy Wheel Guard  
IR1205A019/20

### **14.6.5.5.2. Optional Parts:**

- a)** Side Wall  
IR1203A007/8
- b)** Trimmed Side Wall - IR1203A007/8
- c)** Rear Wheel Backing Plate  
IR1210H001 - 011
- d)** Sidepod Top Infill - IR1202A031/32
- e)** 2/3 Radiator Inlet Shutter  
IR1202A029/30
- f)** Underwing Strake – IR1203A003/4
- g)** Rear Wing Wicker

## **14.6.5.6. Fontana**

### **14.6.5.6.1. Mandatory Parts:**

- a)** Rear Mainplane, 0 > -10.5 degrees  
IR1205B001
- b)** Rear Mainplane Profile  
IR1205B011(RH)  
IR1205B012(LH)
- c)** Rear Indy Wheel Guard  
IR1205A019/20

### **14.6.5.6.2. Optional Parts:**

- a)** Underwing Side Wall - IR1203A007/8
- b)** Trimmed Side Wall - IR1203A007/8
- c)** Rear Wheel Backing Plate  
IR1210H001 - 011
- d)** Sidepod Top Infill - IR1202A031/32
- e)** 2/3 Radiator Inlet Shutter  
IR1202A029/30

### **14.6.5.6.3. Unapproved Parts:**

- a)** Underwing Strake  
IR1203A003/4
- b)** Rear Wing Wicker

## **14.6.6. Sidepods / Underwing**

**14.6.6.1.** The underwing protectors 1203A026/027 or IR-1203A029/030 are mandatory at all Events.

**14.6.6.2.** Sidepod shelves must remain removable as supplied.

**14.6.6.3.** Buckeye covers and funnels must remain removable as supplied.

**14.6.6.4.** Standard bodywork as supplied in technical inspection must be able to fit and be fastened at any time, utilizing all original fasteners.

**14.6.6.5.** Radiator screens are open to teams (mesh and honeycomb); vertical internal turning vanes may be added to the radiator ducts.

**14.6.6.6.** Overall width of the bodywork may not exceed 79.200 inches.

**14.6.6.7.** Only the following types of radiator blanking are approved:

- a)** Dallara Inlet Shutter – Entrants are permitted to trim the standard Dallara inlet shutter in the specified locations and are permitted to add mounting flanges to the backside of the panel.

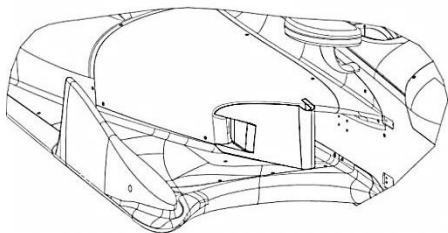

- b) Dallara Blanking Panel** –This part may be manufactured by an Entrant or purchased from Dallara. Panels must be mounted perpendicular to the Car centerline in the approved location at the entrance to the radiator inlet duct.

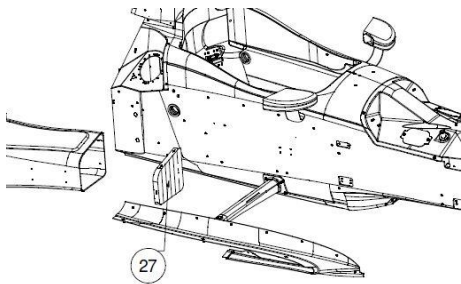

- c) Front and/or Rear Radiator Panel** –These parts are manufactured by an Entrant and must be mounted on the front or backside of the radiator. Panels must be a flat and may have a small return whose sole purpose is to provide a fixing to maintain the location.

**14.6.6.8.** Sidepods and underwings must be able to withstand two (2) load checks.

a) The maximum front deflection allowed will be 0.275 inches with a suspended load of 75 pounds.

b) The maximum rear deflection allowed will be 0.200 inches with a suspended load of 75 pounds.

**14.6.6.9.** No paint may be added to the underwing surface from a point 2.000 inches behind the leading edge of the underwing. From this point aft only clear coating may be applied.

**14.6.6.10.** The underwing step plane heights must adhere to the following illustration. The heights of 1.250 inches, 1.370 inches, and 1.400 inches have a tolerance of plus 0.150 inches and minus 0.00 inches.

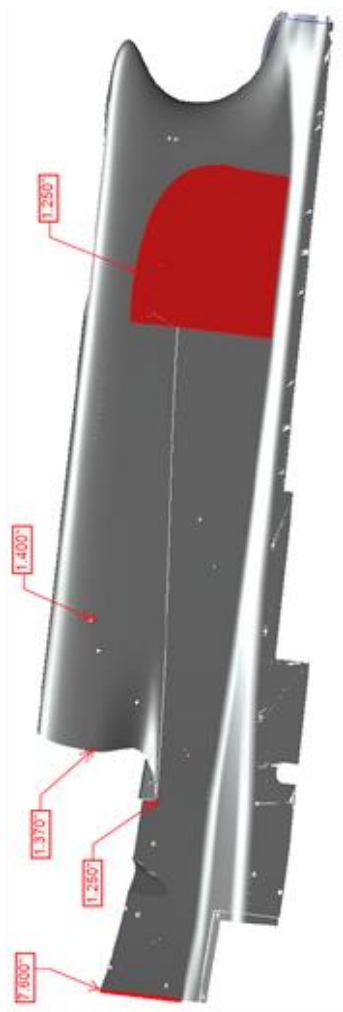

**14.6.6.11.** The complete underwing as provided by Dallara cannot be modified or altered. The underwing must be used in the configuration designated by INDYCAR for any specific on-Track Event.

**14.6.6.12.** Ballast cannot be bolted or bonded to the underwing.

**14.6.6.13.** The exit of the underwing height is 7.600 inches with a tolerance of plus 0.050 inches and minus 0.050 inches.

### **14.6.7. Bodywork**

**14.6.7.1.** An Entrant's Car parts must be able to fit a standard IndyCar Series chassis and standard INDYCAR tech parts must fit the Entrant's Car. All intended shapes and radii must remain as designed.

**14.6.7.2.** All included fasteners must remain and be in the locations as delivered. Entrants are permitted to add extra fasteners.

**14.6.7.3.** The 3 screws that hold the 2 sidepod halves together may be changed to Tridairs but the locations must remain "as is".

**14.6.7.4.** The sidepod shelves, fuel cell covers, buckeye covers, and exhaust outlet panels must remain removable.

**14.6.7.5.** The sidepod shelves, fuel cell covers, and underwing to tub may be blended to reduce the mounting lip. There must be a distinct join line defining each part from its mounting surface.



**14.6.7.6.** The anti-intrusion panel, the underwing vertical fin and the 2014 chassis reinforcement panels may be blended until there are no distinctions between parts. The intended shape and radius of the parts must remain as designed.

**14.6.7.7.** All of the remaining underwing parts (splitters, sidewall extensions etc.) must remain as supplied with the exception of adding extra fasteners or the permitted trim to the underwing sidewall.

**14.6.7.8.** All other parts may be fitted to reduce gaps and uneven heights. In these instances, the chassis should remain as supplied to ensure standard parts can fit. No tongue-and-groove, dovetail, or other types of body fitting will be allowed.

**14.6.7.9.** Tape may be applied to bodywork and chassis junctions or openings providing there is no change to the intended shape or profile of the original part.

**14.6.7.10.** Bell housing cooling duct (Dallara part #: IR1221A004) is optional. The mating part bonded to the radiator inlet duct may be removed.

**14.6.7.11.** Changing of bolt head types is permitted.

#### **14.6.8. Skids**

**14.6.8.1.** Skids must be made to the drawings supplied by Dallara.

**14.6.8.2.** Skids must be made from 3.0mm material or 0.125 inch material.

**14.6.8.3.** Approved materials are brass, stainless steel, aluminum, jabroc, and plastic.

**14.6.9. Radiators** – only approved radiators may be used.

**14.6.10. Airbox** - The airbox must be used as supplied from Dallara. An INDYCAR-approved air filter in the designated location must be used.

## **14.7. Fuel System**

**14.7.1.** The fuel system must remain as supplied by Dallara, with the following exceptions:

- a) Standard collector pot must be used but may be modified. It must continue to be made from aluminum and maintain a cylindrical shape. The volume may not increase by more than 0.100 gallons, and the mounting must remain as supplied. A drain valve must remain at the base of the collector for inspection purposes. Modifications, additions or removal to flap valves, check valves and breathers are examples of permitted modifications.
- b) Standard elephant trunk must be used but the foot may not be less than 3.000 inches from the floor of the fuel cell. Breather holes may be added or removed.
- c) Standard fuel bladder vent must be used but can be modified for fuel cell height. Breather holes may be added or removed.
- d) Plumbing of the fuel cell lines is free.
- e) Filters may be added or changed.

- f) Pressure sensors may be added provided they otherwise comply with the Rules.

**14.7.2.** The maximum capacity of the fuel cell shall be 18.500 U.S. Gallons.

**14.7.2.1.** The only approved method of fuel cell volume reduction is by the addition of fuel cell airtight balls inside the fuel cell.

**14.7.3.** Lanyard-secured self-sealing breakaway valves must be used on the supply and return lines. All installations are subject to the approval of INDYCAR.

**14.7.4.** In the event a fuel cell buckeye is not being utilized at a Race Location, a blanking plate with a minimum thickness of 0.250 inches must be securely fitted utilizing all of the holes in the fuel cell.

## **14.8. Steering and Suspension**

**14.8.1.** Steering wheels must incorporate an approved quick release mechanism.

**14.8.2.** Only the Dallara supplied parts and rack and pinion options may be used. Modifications to the pinion bearing are permitted with INDYCAR approval.

**14.8.3.** Only the Dallara supplied suspension parts may be used. Steel steering arms may be updated to the Dallara drawing below.

<b>Part Number</b>	<b>Dwg Number</b>
IR1206H004	IR1255103
IR1206H005	IR1255107
IR1206H006	IR1255116

**14.8.4.** Suspension parts may not be controlled or activated electronically, with the exception of the weight jacker.

**14.8.5.** One weight jacker may be used at Oval Events only. This must be fitted on the right rear damper of the Car with a maximum travel of 0.500 inch. This must be controlled through the approved control box to which no modifications are permitted.

## **14.9. Dampers**

**14.9.1.** Dampers are an open development component, provided they otherwise comply with this Rule.

**14.9.2.** Damper is a mechanical device utilizing hydraulic fluid to dissipate energy.

**14.9.3.** Each corner must have one damper and one spring. Helper springs, bump rubbers and packers are permitted, provided they are fitted with the primary spring.

**14.9.4.** Front and rear third control springs, bump rubbers, and packers are permitted. No front or rear third dampers, inerters or any other device are permitted nor any modification to the manufacturer supplied parts.

**14.9.5.** Titanium springs are not permitted.

**14.9.6.** Carbon springs may not be used without INDYCAR supplier approval.

**14.9.7.** The dampers must operate independently on each corner of the suspension; they must react directly to the input of that corner as connected to the suspension system.

**14.9.8.** The damper must be attached at one end to the chassis mounting point and the other end directly to the suspension rocker.

**14.9.9.** Connecting dampers side-to-side or front to rear is not permitted.

**14.9.10.** Dampers cannot be adjusted by the Driver.

**14.9.11.** The damper assembly must be contained within the approved designated volume. This CAD file is available from Dallara.

**14.9.12.** No independent inerters or mass dampers are permitted.

#### **14.10. Driveshafts / Hubs**

**14.10.1.** Only Dallara parts may be used as supplied.

**14.10.2.** Dallara wheel lock parts must be used as supplied.

**14.10.3.** Upright bearings and seals must be used as specified by Dallara.

**14.10.4.** Hybrid and/or ceramic bearings are not approved for use.

#### **14.11. Suspension Wheel/Wing Energy Management System (SWEMS)**

**14.11.1.** Front Suspension - The front suspension restraints must consist of a minimum of three (3) SWEMS per suspension corner. All SWEMS must have a break load of 100 kN. The SWEMS must be mounted in Dallara's designated location. All mounting points must be free of sharp edges.

**14.11.2. Rear Suspension** – The rear suspension restraints must consist of a minimum of 3 SWEMS per suspension corner. All SWEMS must have a break load of 100kN. The SWEMS must be mounted in Dallara’s designated location. All mounting points must be free from sharp edges.

**14.11.3. Rear Wing SWEMS** - The rear wing SWEM must consist of:

- a) One (1) SWEM between the mainplane and the attenuator with a break load of 100 kN and mounted in Dallara’s designated location.
- b) One (1) SWEM between the attenuator and the gearbox with a break load of 100 kN and mounted in Dallara’s designated location.

**14.11.4.** The SWEMS must be replaced:

**14.11.4.1.** If a Car sustains an impact on any of the four (4) corners.

**14.11.4.2.** As required by INDYCAR.

## **14.12. Brakes**

### **All Race Locations**

**14.12.1.** Only brake parts as supplied by the approved brake Manufacturer and approved by INDYCAR are permitted. No modifications are permitted.

**14.12.2.** Cars must be equipped with a dual-braking system to operate the brakes effectively on all four (4) wheels. The use of computer logic to control any function of the braking system is not permitted.

**14.12.3.** Any devices designed to push or pull back caliper pistons or pads are not permitted (pull back brakes in any form are not permitted).

### **Road/Street Courses**

**14.12.4.** Only Dallara supplied front and rear brake ducts and brake duct backing plates may be used. These parts may be modified to increase rotor and caliper cooling with INDYCAR approval.

**14.12.5.** Internal ducting within the brake scoop to optimize hub, caliper, and rotor cooling is permitted.

**14.12.6.** Only tape, flat panels, or panels that follow the front contour of the brake duct may be used to regulate the airflow in the brake duct.

**14.12.7.** Both options of brake disc guards may be used:

**14.12.8.** The minimum disc thickness is 0.866 inches.

**14.12.9.** The minimum pad thickness is 0.472 inches.

### **Ovals**

**14.12.10.** The following brake disc guards must be used:  
Front L/R IR1210E008 / IR1210E007  
Rear L/R IR1210H013 / IR1210H012

**14.12.11.** The minimum disc thickness is 0.826 inches.

**14.12.12.** The minimum pad thickness is 0.432 inches.

### **14.13. Wheels**

**14.13.1.** The rim width for front wheels is limited to 10.000 inches. The rim width for rear wheels is limited to 14.000 inches.

**14.13.2.** The only wheel designs approved by INDYCAR are BBS, OZ, and Avus. Only INDYCAR-approved finishes may be used on wheels.

**14.13.3.** The use of wheel covers or inserts is prohibited.

**14.13.4.** Any machining or modification of an approved wheel requires the approval of INDYCAR.

**14.13.5.** The wheel offset may not be modified from design. Subject to Rule 14.13.4, the wheel must be shimmed to bring the wheel back to the designed specification (with the addition of a spacer). The following tolerance must be adhered to when measuring from the high point of the wheel inboard flange to the wheel mounting face.

- Front wheel min. 6.125", max. 6.225"
- Rear wheel min. 7.750", max. 7.850"

**14.13.6.** The maximum service life of wheels is six (6) years from the in service date.

## **14.14. Engine**

**14.14.1.** Only lubricants approved by the Engine Manufacturer may be used. No additives may be used.

**14.14.2.** The exhaust system must be used as homologated by the Engine Manufacturers.

**14.14.3.** Exhausts and exit locations must remain as specified by Dallara. Exhaust / waste-gate pipes must protrude a minimum of 0.250 inch and a maximum of 1.000 inch through the bodywork.



**14.14.4.** Clutch assembly CP8153-DE03-SN carbon plate with steel housing is the only approved clutch.

**14.14.5.** The bellhousing must be used as supplied by Dallara.

**14.14.6.** Entries required to run the INDYCAR supplied torque shaft must maintain a shaft temperature of less than 125 Celsius. Failure to comply will require replacement of INDYCAR equipment, at the Entrant's expense.

## **14.15. Transmission/Differential**

### **All Race Locations**

**14.15.1.** Only transmission parts and gear ratios provided by Xtrac may be used.

**14.15.2.** Treatments and coatings are free; the Xtrac logo/etching must remain on all original parts.

**14.15.3.** Different rotary lip seals are used in the 1011 gearbox. Original parts that are etched with the Xtrac part number and logo must be used. As below:

**a)** 00P-100-0111A, 40x52x7 Lipseal, Used in Front Cover (Input Shaft) and Rear Cover (Starter Shaft).

**b)** 00P-100-0109A, 98x120x12 Lipseal, Used in Side Cover (LH Output Flange) and Maincase (RH Output Flange).

**14.15.4.** The approved paddle shift gear selection system must be used at all Race Locations. The paddle shift system must be used as supplied and without modification.

**14.15.5.** The transmission must maintain all six (6) fully meshed gears during an on-Track Event. Reverse gear must be operational throughout all Events.

**14.15.6.** Entrants must provide seal locations comprised of two (2) drilled holes with a minimum of 0.032 inches in each of the following locations:

- a) Transmission to bellhousing
- b) Transmission rear and side covers
- c) Bellhousing to the Engine
- d) Engine to the bulkhead

### **Road/Street Courses**

**14.15.7.** All parts of the differential assembly must be used as supplied by Xtrac.

**14.15.8.** The clutch stack may be re-arranged, provided all parts remain as supplied.

### **Ovals**

**14.15.9.** Lightweight spool or differential blocker must be used.

### **14.16. Airjack**

**14.16.1.** Entrants must leave the airjack receptacle in the INDYCAR-approved location.

### **14.17. Electronics**

- 14.17.1.** All Cars must be equipped with an ignition switch that can be activated by the Driver. The ignition switch must be clearly marked.
- 14.17.2.** The Dallara supplied fire bottle switch must remain in the designated location.
- 14.17.3.** The master switch must be used as supplied by Dallara. The switch must energize the on-board fire extinguisher and shut off the ignition. The switch shall be clearly marked by a decal, which will be supplied by INDYCAR. Entrants must not disconnect the switch. When a master switch is pulled, it must remain in that state until manually reset.
- 14.17.4. Rain Light** - Only the Dallara supplied rain light may be used. The assembly must be mounted to the attenuator in the INDYCAR designated location.
- 14.17.5. Electronic Logic Processors** – With the exception of an INDYCAR-approved Engine, clutch, gearbox and weight jacker control, the use of electronic logic processors or devices to electronically control any Car function are not permitted.
- 14.17.6.** Only the INDYCAR-approved data acquisition system may be used.
- 14.17.7.** Electronic data of any type may not be transmitted wirelessly to a Car.
- 14.17.8.** The following Cosworth supplied sensors must be used:

<b>Part Number</b>	<b>Description</b>	<b>Quantity</b>
01B-601454	50mm Linear Lightweight Damper Pot	4
21A-0180	30deg "D" Shaft Twin Track Rotary Throttle Position Pot	1
01B-601222	150 degrees Gearbox Temperature Sensor	1
SG-00648	SG06 Dallara IC2012 Front Strain Gauge Push Rod	2
SG-00649	SG06 Dallara IC2012 Rear Strain Gauge Push Rod	2
21A-0181	345deg Flat Shaft Twin Track Rotary Gear Position Pot	1
01B-606021-C	150mm HighTemperature Wheelspeed Sensor	4

**14.17.9.** The following additional chassis sensors are permitted:

- a)** Tire pressure sensors;
- b)** Brake pedal position
- c)** Brake m/c displacement
- d)** A maximum of two (2), 3-axis chassis accelerometers;
- e)** A maximum of four (4) single axis hub accelerometers, 1 per corner;
- f)** Strain gauged suspension parts;
- g)** Strain gauged steering shaft;
- h)** Beacon receiver;
- i)** Laser ride height;
- j)** Gyro or angular rate sensors;

- k)** Roll bar positions;
- l)** Weight jacker position;
- m)** Clutch position;
- n)** Any chassis pressure (pitot, underwing, etc.) limited to diaphragm-type sensors;
- o)** Any chassis temperature;
- p)** Fluid level sensor; and
- q)** Piezoelectric sensor;

**14.17.9.1.** Entrants are permitted to relocate the rear laser provided the laser must remain inside the bodywork and rear end cover (IR-1203A009). The location and mounting must be submitted to IRIS for INDYCAR approval.

**14.17.10.** The weight jacker position can only be controlled by the Driver.

**14.17.11.** The TCR and antenna must be mounted in the INDYCAR-designated location.

**14.17.11.1.** The TCR dash light must be mounted in the INDYCAR-approved location.

**14.17.11.2.** A minimum of two TCR steering wheel lights must activate simultaneously with the TCR dash lights.

**14.17.12.** Chassis and Engine looms must be used as supplied by Cosworth and the Engine Manufacturers.

**14.17.13.** At the conclusion of qualifications, the Race and as directed by INDYCAR, Entrants shall not download data from the Car after receiving the checkered flag until released from technical inspection.

#### **14.17.14. Push to Pass Parameters**

##### **14.17.14.1. INDYCAR Controlled Parameters:**

- a) **tOvertakeMaxMandated** – the total overtake time per push. See table below.
- b) **tOvertakeActivationDelay** – the delay between button being pressed and the push to pass becoming active. This will be 0.000 seconds.
- c) **tOvertakeLockout** – the time after a push to pass event for which the activation is disabled. This will be 0.000 seconds.
- d) **pPlenumOverBstThreshOvertake** – the boost penalty threshold during push to pass. This will be 161kPa.
- e) **nEngHardLmtOfstOvertake** – the hard limiter offset for push to pass. This will be +200rpm.
- f) **tOvertakeResetAllowed** – the minimum Engine stop time to reset the push to pass time. This will be 100 seconds.
- g) **NOvertakeMax** – the maximum number of push to pass activations per Race. See table below.

<b><u>INDYCAR CONTROLLED PUSH TO PASS PARAMETERS</u></b>			
<b>Event</b>	<b>Total Pushes</b>	<b>Time Per Push</b>	<b>Total Time</b>
St. Petersburg	10	15	150
Barber	10	20	200
Long Beach	10	20	200
IMS Road Course	10	20	200
Detroit	10	15	150
Toronto	10	20	200
Mid-Ohio	10	20	200
Sonoma	10	15	150
Houston	10	15	150

**14.17.14.2.** Any attempt to reset NOvertakeRemaining during a Race vent will result in a penalty.

**14.17.15.** At any Event where Cosworth (Live on Air) Telemetry is supported, or at any Event where point-to-point telemetry is utilized, the following data must be transmitted via CAN or serial to INDYCAR:

Channel Name	Hz
Car Number	10
Vehicle Speed	10
Engine Revs	10
Engine Throttle	10
Gear Number	10
Front Brake Pressure	10
tOvertakeRemaining	5
NOvertakeRemaining	5
Tire Type	5
Front Left Tire Sensor ID	1
Front Right Tires Sensor ID	1
Rear Left Tire Sensor ID	1
Rear Right Tire Sensor ID	1
Steering Angle	10
Lap Distance	10
Longitudinal Acceleration	10
Lateral Acceleration	10
Vertical Acceleration	10

## 14.18. Fuel

**14.18.1.** Fuel must be used as supplied by INDYCAR with no modification (removal or addition).

**14.18.2.** The addition of any performance-enhancing substance to the fuel, air, or fuel/air mixture is prohibited.

**14.18.3.** The fuel contained in the Car's fuel system must not be cooler than five (5) degrees Celsius below ambient temperature.

**14.18.4.** Fuel allotments are as follows:



**14.18.4.1.** For Indianapolis 500® Mile Race and Superspeedway Races, the quantity of fuel allotted in the pit tank is equal to 4mpg for the Race distance. The Race distance includes parade and pace laps.

**14.18.4.2.** For Road/Street Courses/Short Ovals, the quantity of fuel allotted in the pit tank is equal to 3mpg for the Race distance. The Race distance includes parade and pace laps.

**14.18.4.3.** For all Races, each Entrant may choose the quantity of fuel in the Car prior to entering pit lane for the Race. Fuel must be added to the Car from the fuel depot.

**14.18.5.** Prior to gridding, each Entrant will be permitted to plug in its fuel hose to top off its Car's fuel tank.

**14.18.6.** Portable containers are not permitted on pit lane.

**14.18.7.** Fuel may not be stored in the Entrant's garage.

**14.18.8.** Local fire codes are a part of the Rules.

## **14.19. Refueling**

**14.19.1.** The use of the refueling probe safety system is mandatory.

**14.19.2.** All refueling nozzles and refueling receptacles must be returned to the manufacturer for servicing prior to the St. Petersburg Race, Indianapolis 500® Mile Race, and Mid-Ohio Race.

**14.19.3.** During a Race, all refueling must be performed by the INDYCAR-approved dry-break disconnect system.

During refueling, only the fuel hose and vent hose can be attached to the fueling system. The fuel flow must be gravity-feed only, and the vent hose must not have any evacuation assist devices attached.

**14.19.3.1.** The refueling coupling must be used as supplied by Red Head Valves - Model VF 1100 M-3 fuel probe with Red Head Valves Model VF 1100 F-3 receiver.

**14.19.3.2.** All refueling hoses must be used as supplied by the Salem Republic Rubber Company (part #P7310-7F-A1298-030-1050GG). Refueling hoses must have a minimum length of ten (10) feet.

**14.19.3.3.** Fuel hose supports may not be longer than forty eight (48) inches and must be approved by INDYCAR prior to use.

**14.19.3.4.** All refueling hose-to-probe connectors must be used as supplied by Rapid Prototyping & Engineering, Inc. (part #INDYCAR 0512).

**14.19.3.5.** The refueling hose-to-tank connector remains open for development. The inside diameter of all refueling hoses, fittings and connectors shall not exceed three (3) inches.

**14.19.4.** Only Dallara supplied fuel cell and vent systems may be used.

**14.19.5.** Entrants may be required to demonstrate the performance of all system parts prior to use. All refueling probes and fuel hoses must be inspected and sealed by INDYCAR before being placed on fuel storage tanks prior to each on-Track Event.

#### **14.19.6. Practice Fueling**

**14.19.6.1.** A single hose with a maximum outside diameter of 1.500 inches incorporating an approved self-closing valve at the tank end must be used.

**14.19.6.2.** Fuel may only be added through the dry-break vent system. The Engine must be shut off during any practice refueling. A crew member must operate fire equipment during any refueling.

# 15. TIRES

## 15.1. General Tire Rules

**15.1.1.** Only tires provided by Firestone and approved by INDYCAR may be used. The tires must be used in the designated location. No Entrant may sell, trade, or otherwise reassign, give or transfer tires to any other Entrant.

**15.1.2.** Changing tires on the pre-Race grid is not permitted without INDYCAR approval.

**15.1.3.** Tire warmers are not permitted.

**15.1.4.** No substance may be applied to the tires.

**15.1.5.** The only tires which may remain in an Entrant's possession are tow tires, set-up tires, rig testing tires and two (2) sets of rain tires. All other tires must be returned to Firestone immediately following the on-Track Event (including all Testing) in which they were used. Tires not returned shall be deducted from the Entrant's allotment at the following Event.

**15.1.6.** Only nitrogen or compressed air may be used to inflate tires.

## 15.2. Tire Allotments

**15.2.1.** Each Entry is permitted the following:

Event Location	Prime	Alternate	Rookie/Out side Top 10	Carry over
St. Petersburg	5	3		
Long Beach	4	3	1	1
Barber	4	3	1	
Indianapolis RC	5	3		
Indianapolis 500	33	-		
Detroit	8	3	1	1
Texas	10	-	1	
Houston	8	3	1	1
Pocono	15	-		
Iowa	8	-	1	
Toronto	8	3	1	1
Mid-Ohio	4	3	1	
Milwaukee	7	-	1	
Sonoma	4	3	1	
Fontana	15	-		

**15.2.1.1.** With the exception of Super Speedway Events, Entries completing five (5) or more laps during practice session 1 will earn an additional set of primary tires. These laps may consist of any combination of "in" and/or "out" laps.

**15.2.1.2.** At the Race Location referenced in Rule 15.2.1, Rookie Drivers and Entries outside the top 10 in Entrant point standings have the option to purchase one (1) additional set of tires for use during practice session one (1). If purchased, the additional set of tires must be returned at the conclusion of practice session 1.

**15.2.2.** After a Street Course, the quantity of new sets of tires remaining may be carried forward to a future Street Course as primary tires. A maximum of one (1) additional set of tires carried forward may be added to

the Entry's primary allotment at a future Street Course. Firestone must be notified of the intent to use the carried forward tires fourteen (14) days prior to the start of the intended future Street Course.

**15.2.3.** An Entry is permitted a total of fifty four (54) sets of tires (primary or wet tires) for Testing Days, made up of the following: Engine Manufacturer Tests, Team Tests, Open Tests, and Full Size Wind Tunnel Tests.

**15.2.4.** Each additional test day approved by INDYCAR will be allocated up to three (3) sets of additional tires.

**15.2.5.** Any remaining new tires from an Entry's Race Location allotment may be added to the Entry's Test allotment per Rule 15.2.3. These tires are not Race Location specific and subject to availability. Alternate tires will not be released for Testing. Remaining new sets of alternate tires will be returned to the Entrant as primary tires.

**15.2.6.** The Event replacement tire allotment is twelve (12) tires for the racing season.

- Primary: 2 tires (max) per Race Location
- Alternate: 1 tire (max) per Race Location (5 for season)

**15.2.6.1.** Unused replacement tires returned to the mounting area will be credited to the Entry's allotment.

**15.2.7. Wet Tires:** Wet tires may not be used prior to the Race without approval of INDYCAR.

**a) Single Event Race Weekends:** A maximum of five (5) sets of "wet" tires (including two (2) sets transported by the Entrant).

**b) Double-Header Event Race Weekends:**

A maximum of six (6) sets of “wet” tires (including two (2) sets transported by the Entrant).

**15.3. Race Tire Rules**

**15.3.1.** Within thirty (30) minutes of the completion of the session prior to the Race, an Entrant must declare via instant messaging or submission of declaration form to INDYCAR which compound it intends to use at the start of the Race. Failure to comply will result in the Entrant being allocated the compound by INDYCAR.

**15.3.2. Single Races:** One set of new (sticker) alternate tires and one set of primary tires must be used during the Race prior to receiving the checkered flag.

**15.3.3. Double-Header Races:** One set of alternate tires and one set of primary tires must be used during each Race prior to receiving the checkered flag.

**15.3.3.1.** If conditions warrant changing to “wet” tires during an Event, Rules 15.3.2 and 15.3.3 no longer apply.

**15.3.3.2.** A Car must complete two (2) official laps on each type of tire, one of which must begin under a Green Condition as is determined by the leader. The second lap may be completed in pit lane even if the Car is pitted prior to the Start/Finish line. At Race Locations where the pit entry is after the start/finish line, two laps must be completed on-Track. Any Entrant failing to comply with this Rule shall receive a minimum one (1) lap penalty. If a Car receives tire damage due to contact, the two (2) lap requirement for that type of tire will be considered fulfilled.

## 15.4. Practice Tire Rules

### 15.4.1. All Races except Indianapolis 500® Mile

**Race:** practice session 1 shall consist of two (2) groups.

**15.4.1.1. Group A:** Only Rookie Drivers and Entrants outside the top ten (10) in Entrant point standings may participate in Group A. Entrants shall have the option to purchase one additional set of tires for use during practice session one (1). If purchased, the additional set of tires must be returned at the conclusion of practice session 1. Entrants within the top ten (10) in Entrant point standings are permitted to perform a "system check". At the beginning of practice session 1, the Car leaves pit lane and returns to pit lane without having completed one timed lap on the Racing Surface.

**15.4.1.2. Group B:** All Entrants entered in the Event may participate in Group B. Entrants completing five (5) or more laps during practice session 1 (Group B) will earn an additional set of primary tires. These laps may consist of any combination of "in" and/or "out" laps.

**15.4.1.3.** If Group A and B are combined, those that would have participated in Group A are eligible to purchase the additional set of tires.



## 16. ENGINE SPORTING REGULATIONS

### 16.1. General

- 16.1.1.** Only the Engine provided by the Engine Manufacturer or its designee and approved by INDYCAR may be used and no modifications are permitted.
- 16.1.2.** An Entry may possess a maximum of one Engine at any time unless otherwise approved by INDYCAR. Engines for Backup Cars are not allowed unless approved by INDYCAR.
- 16.1.3.** All Engine use planning will be carried out by the Engine Manufacturer. INDYCAR will allocate the Engines to the Entries and will randomly assign Engines to Entrants from a pool, designated by noon the Day prior to on-track activities at the Event. If a new pool is not designated, the pool from the previous Event will carry over. The pool for Indianapolis 500® Mile Race must be designated by the conclusion of Qualifying. Fitting an Engine that is not from an Event's pool will be classed as an Unapproved Engine Change-Out. Such an Engine will not be eligible to score Engine Manufacturer championship points.
- 16.1.4.** Each Full-Season Entry is allowed four fresh built Engines from the first Open Test until the end of the Race season. Engines beyond the fourth (4<sup>th</sup>) fresh Engine may be fresh or part-used.
- 16.1.5.** Only one Engine will be provided for the entire Short Indy-500 Program. At the completion of the Indianapolis 500® Mile Race all miles remaining on the Engine shall be forfeited.

**16.1.6.** INDYCAR will seal Engines prior to installation into the Car (seals may be applied to head to block, block to sump, front cover to block, or as otherwise determined by INDYCAR). Seals may not be broken, tampered with, or removed without the permission of INDYCAR. Engine Manufacturers will provide locations and necessary drillings for the application of INDYCAR seals. No Car may participate in on Track activities during an Event without INDYCAR seals in place.

**16.1.7.** If a Driver is replaced at any time, the replacement will be deemed to be the original Driver for the purposes of assessing Engine miles.

## **16.2. Full-Season Mileage Limit**

**16.2.1.** Full-Season Entries are allotted 10,000 miles of running, from the end of the 2013 Race season to the end of the 2014 Race season under the standard full-season Engine program ("Full-Season Entry Mileage Pool").

**16.2.2.** Except as provided below, all Engine mileage shall be subtracted from the 10,000 mile allotment, regardless of Use. Mileage will be determined from the official lap count from the timing sheets of each Event multiplied by the official Track length. Race pace laps and Oval qualifying warm-up laps will be included. For those Events not run on Track, such as straight-line Tests, or where timing sheets are not available, mileage will be calculated from ECU data and provided to INDYCAR by the Engine Manufacturer within 48 hours of completing the Test. All mileage will be rounded to the nearest mile for the purposes of deciding compliance with these Rules.

**16.2.3.** An Entry participating in a tire or chassis Test required by INDYCAR may fit a Manufacturer engine for

that test without penalty. Such Engine Changes must comply with Rule 16.3.2. Engine miles used for tire and chassis Tests required by INDYCAR will not count against the Entry's season mileage limit.

**16.2.4.** Miles used on a Manufacturer test Engine supplied for a Manufacturer test will not count against the Entry's season mileage limit.

**16.2.5.** The Engine Manufacturer may charge an Entrant for miles run by an Entry in excess of the allotted Full-Season Entrant Engine Mileage during the period detailed in Rule 16.2.1.

### **16.3. Engine Change-Out**

**16.3.1.** Before the first Open Test and after the last Race of the Season, an Entry is free to change-out Engines as it deems appropriate without penalty or without the prior approval of INDYCAR.

**16.3.2.** From the start of the first Open Test until the end of the Race season, no Engine may be changed-out for any reason without the prior approval of INDYCAR and the Engine Manufacturer. Engine Change-Outs by an Entry shall be either an Approved Engine Change-Out or an Unapproved Engine Change-Out as determined by INDYCAR. All Unapproved Engine Change-Outs shall be subject to penalty.

### **16.4. Engine Repair**

**16.4.1.** All Engine repairs during an Event must have prior approval from INDYCAR. An Engine that requires a minor repair may, with INDYCAR's approval, be removed from the Car for repair without penalty. Using the Car on Track with another Engine will be classed as an Engine Change-Out.

**16.4.2.** Minor repair shall be a repair that can be performed without the removal of either cam cover.

**16.4.3.** If any of the INDYCAR-applied Engine seals needs to be broken or removed, the repair cannot be carried out unless an Official is present and INDYCAR gives prior approval. If the repair is carried out at the Engine Manufacturer's shop, the Engine Manufacturer will pay reasonable pre-approved travel expenses for the Official being present.

**16.4.4.** Parts may only be replaced with parts to the same design as those removed or with INDYCAR-approved upgrades.

**16.4.5.** The Engine Manufacturer shall be permitted to rerun the Engine on its dyno for the purposes of assuring the minor repair is effective. The Engine must be returned to the Entrant within 28 (twenty-eight) days of its removal. The Entrant changing out the Engine must refit the repaired Engine when the Engine in the Car needs replacing following the Entrant's receipt of the repaired Engine.

**16.4.6.** If the repair becomes non-minor, Rule 16.5.7 will apply.

## **16.5. Approved Engine Change-Outs**

**16.5.1.** The minimum mileage threshold ("Change-Out Mileage") is 2500 miles.

**16.5.2.** An Engine that has reached its Change-Out Mileage may be changed without penalty. The Manufacturer will be awarded points pursuant to Rule 10.6.5.

**16.5.3.** After qualifying is complete at an Event, any Engine that would exceed 2850 miles prior to the end of the scheduled Race distance may be changed without incurring a penalty.

**16.5.3.1.** After Race One of a double-header weekend is complete, any Engine that would exceed 2850 miles prior to the end of the scheduled Race Two distance may be changed without incurring a penalty.

**16.5.3.2.** Engines changed out under Rule 16.5.3 or 16.5.3.1 will be considered to have met Rule 16.5.2.

**16.5.4.** Full-Season Entrants and Entrants running the Full Indy 500 Engine Program may change out their qualifying Engine for a fresh Engine for the Indianapolis 500® Mile Race without penalty subject to availability and the following conditions:

- a) The fresh Engine fitted for the Indianapolis 500® Mile Race shall count as one of the four fresh built Engines allotted to the Full Season Entrant, pursuant to Rule 16.1.4.
- b) Full-Season Entrants have the choice to use up the changed-out Engine or to use up the Indianapolis 500® Mile Race Engine first. Should the changed-out Engine be refitted before the Indianapolis 500® Mile Race Engine reaches its Change-Out Mileage, it must remain in the Car for the balance of its Change-Out Mileage. Except as under Rules 16.2.3 and 16.5.6, both Engines must reach their Change-Out Mileages before another Engine can be fitted to the Car.
- c) Entrants only participating in the Indianapolis 500® Mile Race shall forfeit all unused miles on both the

practice and qualifying Engine and/or the Race Engine at the conclusion of the Indianapolis 500® Mile Race.

**16.5.5.** An Engine that has experienced a problem deemed sufficient to require change-out as mutually agreed by INDYCAR and Engine Manufacturer that is beyond the reasonable control of either the Entrant or Engine Manufacturer (such as faulty fuel, damage to the Engines caused by act of God, etc.) may be replaced with an Engine from the pool without penalty.

**16.5.6.** An Engine that has experienced a problem during participation in a predetermined special/non-Race Event will be classed as an Approved Engine Change-Out. Such Events will be determined by INDYCAR, and Entrants will receive notification prior to the Event.

**16.5.6.1.** For the pit stop competition held during the Indianapolis 500® Mile Race, Manufacturers are free to substitute any Engines for assigned Engines with INDYCAR approval.

**16.5.7.** An Engine that fails or presents evidence that failure has started may be changed without penalty provided the following conditions are met:

- a) The Manufacturer presents the evidence of failure to the INDYCAR Director of Engine Development or his appointed representative; and
- b) Engine Manufacturer shall be responsible for repair costs of the Engine including parts, labor, shipping, etc
- c) INDYCAR approves the change and assigns the Entrant with a fresh Engine from the pool.

**d)** Rule 10.6.5. will apply.

**16.5.8.** Changing an Engine before the Change-Out Mileage because it has been operated outside of the Engine Manufacturer's guidelines (such as: Engine spinning backwards, loss of fluids, crash damage, etc.) will be subject to the following:

- a)** Entrant shall be responsible for all repair costs of the Engine including parts, labor, shipping, etc.
- b)** Only upon payment in full to the Engine Manufacturer for the repair shall the Entrant be credited the unused mileage of the Engine and be supplied a fresh or a used replacement Engine from the pool.

## **16.6. Unapproved Engine Change-Outs**

**16.6.1.** An Entry choosing to change an Engine without complying to Rule 16.5 will be classified as an Unapproved Engine Change-Out.

**16.6.2.** Any Unapproved Engine Change-Out will result in the following:

**16.6.2.1.** The Entry will start the next Race from the back of the grid. If more than one Entry is serving an Unapproved Engine Change-Out penalty at an Event, they will line up at the back of the grid in the order determined by Rule 8.1.8.6. If an Entrant makes two Unapproved Engine Change-Outs during an Event, the grid penalty for the second Unapproved Engine Change-Out will be served at the following Race.

**16.6.2.2.** Rule 10.6.4 will apply for each Unapproved Engine Change-Out.

**16.6.2.3.** No Engine Change-Out grid penalties will be served during the Indianapolis 500® Mile Race but points penalties will be applied. Penalties carried over into or earned at the Indianapolis 500® Mile Race will be served at subsequent Races.

**16.6.2.4.** Entries not participating in consecutive Events will not carry-over any Engine Change-Out penalties.

**16.6.3.** No Engine Change-Out will be subject to more than one Unapproved Engine Change-Out penalty.

**16.6.4.** No Engine Change-Out penalty will carry over to the following season.

**16.6.5.** Changing an Engine before the Change-Out Mileage because it has been damaged by the actions of the Entrant ("Team Abuse") including, without limitation, use of non-approved fuels or oils, tampering with the boost control or rev limit functions, continuing to operate the Engine after being informed that a problem has occurred such as overheating, etc. will be subject to the following:

- a) Entrant shall be responsible for all repair costs of the Engine including parts, labor, shipping, etc.
- b) All mileage remaining on the Engine prior to the Team Abuse incident shall be forfeited.
- c) Entrant may be subject to other penalties up to and including termination of the Engine service agreement.



**d)** The change out will be classed as an Unapproved Engine Change-Out.

**16.6.6.** Removing the Engine to test a Down on Power ("DOP") claim shall be classed as an Unapproved Engine Change-Out. The procedure for, and penalties potentially arising from, a Down on Power claim are set out in Rule 16.7.

## **16.7. Down On Power Engines**

**16.7.1.** An Entrant claiming an Engine is DOP is required to provide supporting data to the Engine Manufacturer before the claim will be considered. The Engine Manufacturer, in its sole Discretion, shall determine if the DOP claim is valid.

**16.7.2.** If the Engine Manufacture accepts the DOP claim, the Engine Manufacturer shall inform INDYCAR of the issue. INDYCAR shall inspect the supporting data and in its Discretion determine if the DOP claim is valid. If it is determined by all parties that the Engine is DOP, INDYCAR shall:

**a)** Approve the Engine Change-Out; and

**b)** INDYCAR will assign the Entrant with a fresh or a used Engine from the pool for the outstanding miles of the DOP Engine. For Engine mileage accounting purposes, the reworked or rebuilt Engine will count as a substitute for the Engine that was removed.

**c)** Rule 10.6.5 will apply

**16.7.3.** If an Engine Manufacturer does not accept that a DOP claim is valid, the Entrant making the claim may, in its Discretion, pay the DOP bond specified in Rule 16.7.4

to INDYCAR to have the Engine removed from the Car and be retested by the Engine Manufacturer.

**16.7.3.1.** INDYCAR will retain the DOP bond until an Engine power test is completed at the Engine Manufacturer's facility. The retest of the Engine must be completed within 15 working days of the DOP claim. INDYCAR reserves the right to be present at the test.

**16.7.3.2.** In a case where the DOP Engine retests within 2% of its shipping test performance between 9,000 and 12,000 rpm:

- a) The Entrant shall forfeit the DOP bond, and INDYCAR shall pay the DOP bond to the Engine Manufacturer;
- b) The Entrant will pay for INDYCAR's costs for being present at the power test; and
- c) The Entrant shall forfeit the unused portion of the Engine mileage; and
- d) Rule 10.6.4 will apply.

**16.7.3.3.** If the Engine retests more than 2% under its shipping test performance between 9,000 and 12,000 rpm:

- a) INDYCAR shall return the DOP bond to the Entrant;
- b) The DOP bond will not increase the next time that Entrant makes a claim; and
- c) The Engine Manufacturer will pay for INDYCAR's costs for being present at the power test; and

**d)** The Engine Manufacturer will supply the Entrant with an Engine from the pool for the outstanding miles of the DOP Engine. For Engine mileage accounting purposes, the replacement Engine will count as a substitute for the Engine that was removed; and

**e)** Rule 10.6.5 will apply.

**16.7.4.** For an Entrant's first DOP claim, the DOP bond is \$25,000. For Entrant's second and subsequent claims the DOP bond is \$50,000. For Entrants only participating in the Indianapolis 500® Mile Race, the DOP bond is \$50,000.

## **16.8. Single Race Event Only Program**

**16.8.1.** Engine Manufacturers will support single Race Event Entries approved by INDYCAR. The Entry may use only the Engine provided by the Engine Manufacturer and assigned by INDYCAR.

**16.8.2.** The Entrant shall forfeit all unused miles on the Engine at the conclusion of the Event.

## **17. EQUIPMENT & GARAGES**

### **17.1. Fuel Storage Tanks**

**17.1.1.** Refueling supply must be gravity flow only. The use of pressurization or vacuum during refueling is not permitted. All tanks are limited to a single outlet with a maximum inside diameter of 3.000 inches. The outlet can have a maximum 1.500 inch radius from the tank's external face to the outlet. The maximum length of the outlet including any attachments is limited to 14.000 inches from the front face of the tank.

**17.1.2.** All tanks must be vented to atmosphere at all times using a Protectoseal 3.000 inch flame arrester/vent or equivalent.

**17.1.3.** All tanks must use a spring-loaded valve between the tank flange and vent pipe (for all Race Locations except the Indianapolis 500® Mile Race Event). The following valves are permitted:

- a)** Betts Model WD-305; and
- b)** J.C. Carter Model JC-64075

**17.1.4.** Between the tank outlet and refueling hose, the following valves are permitted:

- a)** Dan Jones Model 06-DJ or J.C. Carter valves: these valves are permitted one (1) splitter with a maximum thickness of 0.300 inches and a maximum length of 3.500 inches. The splitter may be horizontal or vertical, must be mounted in the tank flange, and may not protrude into the tank.

- b) Betts valve:** this valve is not permitted a splitter. Entrants may not alter the vent or spring-loaded closing valve.
- 17.1.5.** All refueling tanks must have a manual air-operated emergency shut-off valve to the probe.
- 17.1.6.** The height of the refueling tanks must be set and sealed by INDYCAR prior to filling.
- 17.1.7.** No part of the refueling storage tank may be closer than 30.00 inches to the front face of the pit wall. The refueling storage tank outlet must be positioned between the center and 18.00 inches rearward of the center in the assigned pit, be square to the pit wall and/or facing towards pit in.
- 17.1.8.** All fuel level sight tubes must have a positive shut-off valve at both ends.
- 17.1.9.** All equipment must comply with the Rules of INDYCAR and where applicable the NFPA (National Fire Protection Association), state and/or local codes.
- 17.1.10.** Refueling tanks and probe must be grounded by an INDYCAR-approved method.
- 17.1.11.** Tank Capacities and Dimensions:

**Indianapolis 500® Mile Race**

Only the fuel tank as supplied by INDYCAR may be used without modification. All fuel tanks must remain on the grounds of the Race Location. Entrants may affix decals to the fuel tanks, but may not paint them. The maximum height of the rear edge of the pit storage tank shall be 80.000 inches measured from the highest point. The maximum

height of the front edge of the tank must be 76.000 inches. The slope of the tank must not exceed 4.00 inches. The vent pipe shall be a minimum of 102.00 inches in height. All refueling tank height measurements will be made from the pit lane surface.

### **Other Race Locations**

Refueling tanks must be built to INDYCAR specifications **(See Illustration)**. Refueling tanks must be a single container made of T304 stainless steel or the equivalent and have a capacity of 152.00 U.S. Gallons. All dimensions are overall measurements with the top surface level. The maximum height of the refueling tank shall be 84.00 inches to the top surface, which must be level. The vent pipe shall be a minimum of 102.000 inches in height. All refueling tank height measurements will be made from the pit lane surface. No modifications may be made to the refueling tank specifications. Drawings for fuel tank are available from the INDYCAR office. All dimensions are in inches.

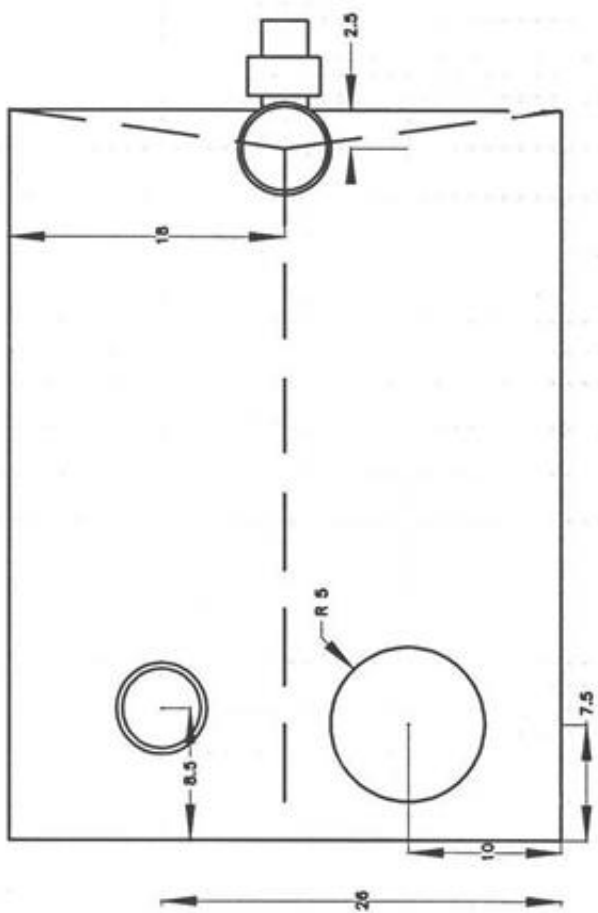

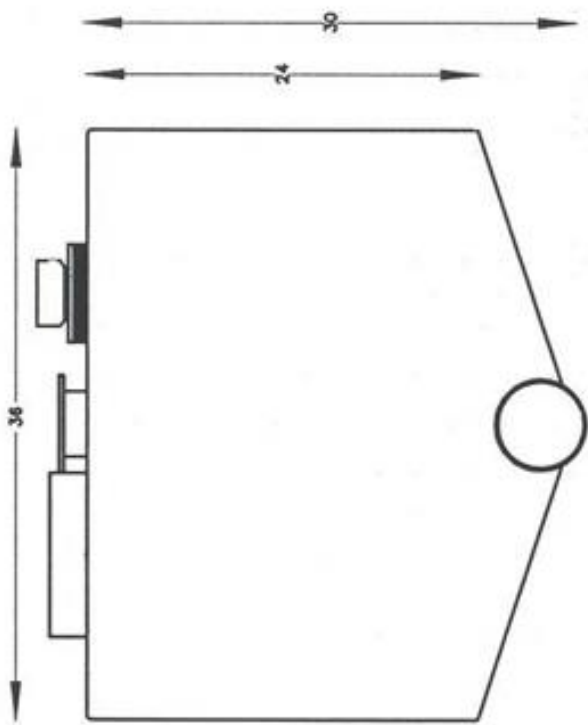



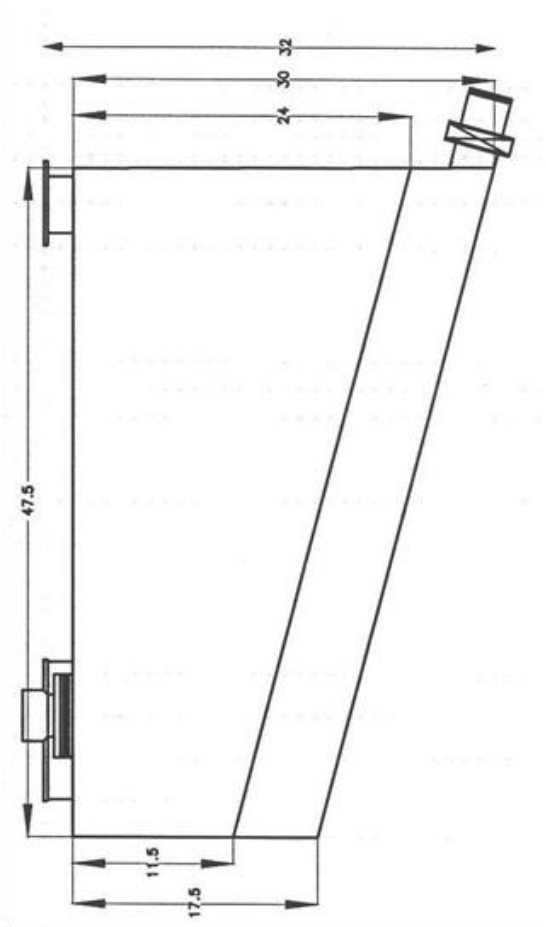

**17.1.12.** All support legs and height-adjusting devices used with the refueling tank must be approved by INDYCAR prior to use. Tank support legs must include feet with adequate area so that the tank, with fuel, will not sink into the pit surface. Metal or wood may be used under the support legs to distribute the load, provided it is not stacked in a hazardous manner. All tanks must include a mechanism approved by INDYCAR by which the tank may be moved away from the pit wall quickly and easily. Any wheels or castors attached to the tank support stand must be raised from contact with the pit surface.

**17.1.13.** Cooling of the fuel in the refueling tank is not permitted.

**17.1.14.** Devices which alter the gravitational flow of fuel are not permitted.

## **17.2. Pit Lane Fire Equipment**

**17.2.1.** The Entrant must have a fully charged ten (10) pound fire extinguisher in the Car's pit area. A gauge must be attached to each fire extinguisher. The mixture must contain ten percent (10%) Coldfire and be equipped with Atomizing Nozzle (Part # CFSE6HATOM, Cold Fire Southeast)

**17.2.2.** Each Entrant must have a minimum of two (2) open containers of water in the Entrant's pit area each with a capacity of five (5) gallons.

**17.2.3.** Each Entrant must have a two (2) pound dry chemical extinguisher.

### **17.3. Equipment**

**17.3.1.** All nitrogen bottles must be securely fastened and have a cage device or other container approved by INDYCAR to protect all valves and regulators. All nitrogen bottles must be returned to the designated location at the conclusion of each on-Track Event.

**17.3.2.** The maximum height of the scoring stand is 84.00 inches measured from the ground to the top of the stand excluding awning. The maximum surface area of an awning is 85 square feet in plan view. INDYCAR may determine if an Entrant may use an awning at a particular facility. Scoring stands using wheels or castors must be chocked or secured from moving, and awnings, flags, umbrellas or shields may be used, provided they do not block spectator viewing.

**17.3.3.** Paint or other permanent markings may not be used in the garage, on the pit lane surface or on the pit wall.

**17.3.4.** Camera booms cannot extend more than 80.000 inches into pit lane and must be approved by INDYCAR.

**17.3.5.** Where permitted an Entrant may display one flag in its pit box, provided the flag is located behind pit wall, is a maximum size of 5 ½ feet wide and 3 ½ feet high, and a maximum height of 14 feet off of the pit floor.

### **17.4. Garage**

**17.4.1.** INDYCAR reserves the right to assign transporter parking, garages, and pits.

**17.4.2.** If garages are available, Entries will receive one (1) garage per Entry. INDYCAR shall allocate a

designated amount of space in the garage area for each Manufacturer.

**17.4.3.** If garages are not available, each Entrant shall receive a maximum 30 feet wide parking location in the garage area to use as a garage for the transporter and tent/awning, unless otherwise noted.

**17.4.4.** Entrant agrees to reimburse Event Promoter for the cost of repairing any damage to the garage area that occurs during occupancy by the Entrant.

**17.4.5.** Tents will not be permitted to extend beyond the rear of the trailer tailgate or front bumper of the tractor.

**17.4.6.** Entrants must submit a diagram of their tent and transporter footprint layout 60 days prior to the first Event and seven (7) days prior for any subsequent changes for INDYCAR approval.

## **17.5. Covers**

**17.5.1.** During the entire Event, no screen, cover or other obstruction which in any way obscures any part of a Car will be allowed at any time.

**17.5.1.1.** In addition to the above the following are specifically not permitted :

- a) Engine, gearbox or radiator covers while Engines are being changed or moved around the garage ;
- b) Covers over spare wings;
- c) Parts such as (but not limited to) spare floors, fuel rigs or tool boxes may not be used as an intentional obstruction.

**17.5.1.2.** Rain covers may be used during inclement weather conditions. No other form of cover may be used.

**17.5.1.3.** Covers which are placed over damaged Cars or components are permitted.

## 18. GLOSSARY

- **ACCUS-FIA** – The Automobile Competition Committee of the United States is the ASN of FIA for the United States. ACCUS is comprised of the six (6) major motorsports sanctioning organizations (known by or within the FIA as "member clubs"): IMSA, INDYCAR, NASCAR, NHRA, SCCA and USAC. In accordance with the FIA Statutes and the International Sporting Code, ACCUS-FIA has delegated its sporting power to the Member Clubs, except for FIA World Championship events.
- **Approved Engine Change-Out** – An Engine change approved by INDYCAR and not subject to penalty.
- **ASN** – The National Sporting Authority of the FIA is a national automobile club or other national body recognized by the FIA as sole holder of sporting power in a country, except that in accordance with the FIA Statutes and the International Sporting Code, an ASN may delegate some or all of its sporting power to its member clubs. An ASN is the liaison between its member clubs, other ASNs and the FIA. An ASN prepares listings on the international calendar, issues international motorsport licenses to its citizens and foreign citizens living in the country, issues authorizations for foreign participation, and certifies and maintains domestic and international records.
- **Associate** – The firm(s), corporation(s) or other business association(s) named on an Associate's membership application approved by INDYCAR, remaining in good standing, and uniquely identified by a tax identification number. Associate includes Associate and Associate's officers, directors, members,

owners, successors, assigns, agents, employees, representatives, and affiliates. Associate includes Manufacturers. Associate is responsible for Associate Group as defined in the associate's membership application.

- **Backup Car** – A spare car an Entrant may use on Track in place of a primary car if approved by INDYCAR.
- **Business Day** - Any day other than a Saturday, Sunday or other day on which commercial banks are authorized to close under the laws of, or are in fact closed in, the state of Indiana.
- **Car** – A four (4) wheel automotive vehicle consisting of the combination of chassis, Engine, transmission and tires. The vehicle must be supplied by Manufacturers, approved by INDYCAR, and conform to the specifications, spirit, and illustrations in, and intent of, the Rules.
- **Competitor** - A Driver, Entrant, crew member, Manufacturer or any other individual or entity who is a Member and participates competitively in an Event.
- **Cosworth** – Cosworth, LLC, an approved electronic supplier. Any reference in the Rules to "Cosworth" is referring to Cosworth, LLC.
- **Dallara** – Dallara, LLC, the approved chassis manufacturer. Any reference in the Rules to "Dallara" is referring to Dallara, LLC.
- **Day** - The twenty-four (24) hour period within a single calendar day.
- **Discretion** - The exercise by INDYCAR of judgment in making a determination as to the application,

construction, and interpretation of the Rules; and is required because of the need for decisions that depend upon immediacy without reflection and/or that are often subjective.

- **Double-Header Race Location** – A Race Location where more than one Race is held.
- **Driver** - The individual named on a Driver's License and membership application approved by INDYCAR and issued by ACCUS-FIA (or another ASN, if applicable) and remaining in good standing. Driver is responsible for Driver Group as defined in the Driver's license and membership application.
- **Engine** - An engine supplied by one of the engine Manufacturers or their designees, approved by INDYCAR, and conforming to the specifications, spirit, and illustrations in, and intent of the Rules.
- **Engine Change-Out** – The replacement of a Car's Engine with another from the same Manufacturer.
- **Entrant** - The firm(s), corporation, or other business association(s) named on an Entrant's License and membership application approved by INDYCAR and issued by ACCUS-FIA, remaining in good standing, and uniquely identified by a tax identification number and Car number. Entrant includes Entrant and Entrant's officers, directors, members, owners, successors, assigns, agents, employees, representatives, and affiliates. Entrant is responsible for Entrant Group as defined in the Entrant's license and membership application.
- **Entry** - An Entrant's Car and Driver combination on an Entry form displaying the Entrant's Car number and approved by INDYCAR for participation in a designated on-Track Event.



- **Event** – Any racing, promotional and/or entertainment or other activities associated with, sanctioned by and/or organized in cooperation with INDYCAR or occurring at the site of, contemporaneously with or reasonably connected to said activities in cooperation with INDYCAR. Event does not include any Indy Lights® Series, Pro Mazda Championship or USF2000 Championship events, as those events are covered by separate rules.
- **Event Agreement** – The agreement in effect between INDYCAR and an Event Promoter regarding the conduct of a Race.
- **Event Promoter** – The firm(s), corporation(s) or other business association(s) named on an Event Agreement with INDYCAR and responsible for designated operations of a Race. Event Promoter includes Event Promoter and Event Promoter's officers, directors, members, owners, successors, assigns, agents, employees, representatives, and affiliates.
- **FIA** - The Federation Internationale de l'Automobile is the sole international sporting authority entitled to make and enforce regulations based on the fundamental principles of safety and sporting fairness, for the encouragement and control of automobile competitions and records, and to organize FIA International Championships.
- **Firestone** - Bridgestone Americas Tire Operations, LLC, is the approved tire manufacturer. Any reference in the Rules to "Firestone" is referring to Bridgestone Americas Tire Operations, LLC.
- **Full Indy 500 Engine Program** –the use of two Engines in the Indy 500 practice/qualifying and Race.

- **Full Season Entrant** – An Entrant scheduled to participate in every Race.
- **Full-Season Entrant Engine Mileage** – 10,000 Engine miles as allotted for a Full Season Entrant.
- **Headings** – The subject headings are included for purposes of convenience only, and shall not affect the construction or interpretation of any of the Rules.
- **INDYCAR** –INDYCAR, LLC, the owner and operator of the IndyCar Series. "INDYCAR", and "Leaders Circle" are registered trademarks with the United States Patent and Trademark Office and cannot be used without authority from INDYCAR or Brickyard Trademarks, Inc.
- **IndyCar Series** - The IndyCar Series owned and operated by INDYCAR. INDYCAR includes INDYCAR and INDYCAR's officials, officers, directors, members, owners, successors, assigns, agents, employees, representative, and affiliates. IndyCar Series (and design) are registered trademarks of Brickyard Trademarks, Inc., used with permission. Any reference in the Rules to the IndyCar Series may include INDYCAR and any reference to INDYCAR may include a reference to the IndyCar Series, if the context so requires.
- **IRIS** – INDYCAR Information System is the official online communication platform for Competitors.
- **Leaders Circle** – The program whereby INDYCAR provides benefits to Entrants and Entrant Group in exchange for their participation in all of the Races. Entrants must submit an application and receive an acknowledgment of acceptance of such application from INDYCAR. Leaders Circle Members must remain

in good standing. Leaders Circle designations may not be transferred, sold or otherwise assigned without prior written permission by INDYCAR. INDYCAR may limit the number of Leaders Circle Members as it deems appropriate.

- **License** - An authorization approved by INDYCAR and issued by ACCUS-FIA (or another ASN, if applicable) to an individual or entity to participate in a Race as a Driver, Entrant or Official.
- **Manufacturer** – The firm(s), corporation(s) or other business association(s) named on an Associate’s membership application approved by INDYCAR, remaining in good standing, and uniquely identified by a tax identification number. Manufacturer includes the approved chassis, tire, Engine, and transmission Manufacturers and their officers, directors, members, owners, successors, assigns, agents, employees, representatives, and affiliates. Manufacturer is responsible for Manufacturer Group as defined in the associate’s membership application.
- **Member** - An individual, firm, corporation or other business association entity named on an annual membership application, approved by INDYCAR, and remaining in good standing. Without limitation, each Competitor and Official must be a Member. Member is responsible for Member Group as defined in the annual membership application.
- **Non-Qualified Car** – A Car not successfully completing qualifications. A Non-Qualified Car may be approved by INDYCAR to participate in a limited manner in a Race.
- **Officials** - Any and all authorized INDYCAR officers, employees, agents, representatives, and

subcontractors. Officials specifically referenced in the Rules include:

“President of Competition and Operations”,  
Derrick Walker

“Vice President of Competition”, Brian Barnhart

“Race Director”, Beaux Barfield

“Medical Director” Michael Olinger, MD

“Medical Review Officer” Douglas Aukerman, MD

INDYCAR may replace any Official with another Official(s) at any time. The above-named Officials may delegate their authority in whole or in part to another Official(s) at any time.

- **Open Test** – An Open Test is a Test organized by INDYCAR to which all Entrants are invited to participate.
- **Oval/Oval Events** – A Race Location where all on-Track turns are left-handed.
- **Participant** - Any individual or entity along with their officers, directors, members, owners, successors, assigns, agents, employees, representatives, and affiliates that are in any way associated or connected with Track premises, testing facilities or other INDYCAR-approved locations or event including, without limitation, facility owners, Event Promoters, municipalities, racing associations, sanctioning organizations, series organizers, Officials, workers, volunteers, Entrants, Car owners, Drivers, pit crew members, safety crew members, medical/rescue personnel, sponsors, Manufacturers, suppliers, designers, advertisers, inspectors, construction

contractors, engineers, architects, insurers, and all individuals in a restricted area.

- **Provisional Starting Car**- An Entrant who is granted permission to start a Race based on previous championships, current points or other means as determined by INDYCAR.
- **Qualified Car** – A Car that successfully completes qualifications.
- **Race** - The feature activities of an IndyCar Series race weekend.
- **Race Location** – A location where on-Track activities take place.
- **Racing Surface** - The area designated by INDYCAR as eligible for use during competition. It may be formed by boundaries such as a wall or a line. It does not include grass or runoff areas.
- **Registration** - The unique identity number assigned to a specific Car by Dallara.
- **Road Course Event** – A purpose-built permanent Track where turns are left and right-handed.
- **Rookie** - A Driver is a Rookie in the IndyCar Series if the Driver has not participated in more than four (4) IndyCar Series Races in a racing season or eight (8) IndyCar Series Races in total.
- **Rookie - Indianapolis 500** - A Driver is a Rookie in the Indianapolis 500® Mile Race if the Driver has not participated a previous Indianapolis 500® Mile Race.
- **Rookie Orientation Program ("ROP")** – A three (3) phase Test, supervised by INDYCAR to

demonstrate Car control, placement, and a consistent driving pattern by a Rookie Driver.

- **Rules** - This 2014 IndyCar Series Rule Book, including without limitation, Engine Regulations, Supplementary Guidelines, Substance Abuse Policy, Social Media Policy, Style Guide and bulletins issued by Officials, whether containing Rules applicable only to a particular Event(s) or containing Rules of general applicability. The Rules are made available in both hard copy and electronic format. Notwithstanding the foregoing, Rules may be issued verbally in mandatory meetings such as Drivers meetings held during Events.
- **Safety Car** – An official Safety Car approved by INDYCAR, driven by an authorized individual and used during on-Track activities.
- **Short Oval Events** –An Oval/Oval Event with a Track distance one (1) mile or less.
- **Speedway/Superspeedway Events** – An Oval/Oval Event with a Track distance greater than one (1) mile.
- **Steward** – An individual designated by the President of Competition and Operations to have specific authority to assist with the application, construction, interpretation and enforcement of the Rules.
- **Street Course Event** - A purpose-built temporary Track where turns are left and right-handed.
- **Team** – One or more Entrants under common ownership and/or control as determined by INDYCAR.
- **Test** - Any period during which a Member conducts any Testing.

- **Testing** - The use of the approved chassis, Engine, transmission, and tires, separately or in any combination during a period other than practice, qualifying or a Race.
- **Track** – The area including without limitation the Racing Surface, pit entrance lanes, pit lane, and pit exit lanes located between the outer and innermost retaining walls.
- **Track Condition** – The status under which on-Track activity is conducted.
- **Unapproved Engine Change-Out** - An Engine change not approved by INDYCAR and subject to a penalty.
- **Use** – This is defined as being propelled under power generated by the Engine.
- **Xtrac** – Xtrac, Inc, the approved transmission manufacturer. Any reference in the Rules to “Xtrac” is referring to Xtrac, Inc.



## 2014 Engine Regulations

Version 6

Revised 16<sup>th</sup> December 2013



## Contents

1	General Introduction .....	3
2	General Regulatory Framework.....	3
3	Internal Combustion Engine Architecture .....	3
4	Homologation .....	6
5	Materials.....	8
6	Fuel Systems .....	9
7	Turbo-Charger Systems .....	9
8	Air Intake.....	10
9	Plenum.....	11
10	Exhaust Systems .....	11
11	Engine Throttles.....	12
12	Control and Logging Systems.....	13
13	Transmission .....	14
Appendix A	Boost sensor location.....	16
Appendix C	Engine to gearbox interface points.....	18
Appendix D	Reference components.....	19
Appendix E	Sunoco E85-R Typical Properties.....	20
Appendix F	Throttle Pedal Position Sensor Specification .....	21
Appendix G	McLaren Crank Speed Sensor Specification .....	22

# 1 General Introduction

## 1.1 Definitions:

1.1.1 INDYCAR is the governing body of the IndyCar Series, based in Speedway, Indiana. In this document the “Series” and INDYCAR should be viewed as interchangeable terms.

1.1.2 INDYCAR Engine Committee (IEC) - A consultative group chaired by the INDYCAR VP of Technology, consisting of representatives from each engine supplier, a representative from INDYCAR plus other invited attendees when appropriate.

1.2 **“Push to Pass”** – INDYCAR has set long term (maximum) goals of an additional 100hp for road/street circuits and 50hp for short ovals and speedways. These will not be introduced without consultation with the IEC.

## 2 General Regulatory Framework

2.1 **Rule Stability** – These rules will be stable for a period of five seasons beginning 2012 (Reference Homologation table B). Corrections and modifications with respect to engine regulations will be decided by INDYCAR after consultation with the IEC.

2.2 **Review of rules** – The IEC will meet regularly to review and to advise on all regulations pertaining to the engine.

The IEC is to develop a roadmap for the future.

2.3 **Demonstration of conformity** – Manufacturers must demonstrate conformity to INDYCAR regulations.

2.4 Anything not expressly permitted by these regulations is prohibited without the written permission of INDYCAR.

## 3 Internal Combustion Engine Architecture

3.1 **Constraints** – The engine will be a four-cycle, four poppet valve per cylinder (two inlet, two exhaust), V6, turbo charged engine subject to the constraints below:

- a) Capacity – 2.200 liter maximum.
- b) Cylinders – Six, all of equal capacity; each round to +/-0.13mm
- c) Bank Angle – between 60° and 90°.
- d) Bore – 95mm diameter maximum

- e) Engine length, including all sealed parts and the plenum, measured from mounting face to mounting face – 460mm. Nothing may extend beyond this length without INDYCAR’s approval.
- f) Crankshaft height – 100mm above bottom of chassis (lowest point of sump)
- g) One piece crankshaft – homogenous with no additional non-ferrous inserts or bolt-on balance weights
- h) Main bearing minimum dimension – 48mm diameter
- i) Big end journal minimum dimension – 40mm diameter
- j) Connecting rods – Homogenous, no welding or bonding
- k) Piston pin – single piece only
- l) Valve type – Reciprocating circular poppet, return force via coil spring only
- m) Spark plug – One per cylinder otherwise free
- n) Ignition system – Coils driven by the mandated ECU only. (Plasma and laser ignition systems are prohibited.)
- o) Coatings – DLC coatings are not permitted on crankshafts, rods, camshafts, piston skirts or sleeves.
- p) Camshafts – Up to four overhead camshafts permitted (2 per bank)

3.2 **RPM** – is restricted by the ECU to 12,000 rpm maximum.

3.3 **Boost pressure** – The maximum absolute plenum pressure is restricted to 130kPa for superspeedways, 140kPa for short ovals, 150kPa for road and street courses, and 160kPa for Push-to-Pass. For Indianapolis qualifying and the day prior, the maximum absolute plenum pressure will be 140kPa.

Boost sensors will be monitored, sealed and supplied by INDYCAR, and fitted in 2 locations – see Appendix A. Interfering with or modifying the signal from these sensors as seen by the ECU is prohibited.

3.4 **Engine Interface** – Engine installation mounting points, gearbox mounting and fuel pump drive must match the mounting points for the chassis and gearbox given in Appendix B and Appendix C without modification to allow teams to use engines from any manufacturer without redesign of interfaces (front and rear end, water and oil radiator connections to the heat exchangers and fuel pump drive).

3.5 **Hydraulic pumps** – For the purpose of actuation and control with the exception of the fuel system are not permitted.

3.6 **Pneumatic systems** – Pneumatic pumps, actuator, or control mechanisms are not permitted, with the following exceptions:

- a) Pneumatic waste-gate mechanisms.
- b) Series-specified gearshift system.

c) Series-specified clutch actuation system.

3.7 **Valve Timing** – Variable valve timing, phasing and lift are not permitted.

3.8 **Propulsion** – No other means of propulsion are permitted.

3.9 **Camshafts** – May be driven only by chain or gears.

3.10 **Electrical fuel pumps** – Are not permitted.

3.11 **Minimum weight** – When measured according to Table A, the engine shall weigh at least 112.5kg. Ballast, securely retained to the satisfaction of IndyCar, may be added to the engine to achieve minimum weight.

When establishing conformity with regards to weight an engine shall include the intake system from the plenum entry manifold(s); ignition coils; engine sensors and wiring; injectors and fuel rails; alternator, cooling and lubrication pumps; flywheel; any type of sub-frame.

The following table shall be referenced when determining engine weight, the intention being that the engine can be weighed in the state of completeness as shipped to teams.

**TABLE A**

	Engine Weight
Turbo charger and exhaust	Excluded
Clutch	Excluded
Clutch actuation	Excluded
Water radiators and accumulator	Excluded
Fuel pumps (except where mounted on or inside the engine)	Excluded
ECU and ignition unit	Excluded
Fuel flow meter	Excluded
Torque sensor	Excluded
Programmable devices and other electronic systems required by the engine	Excluded
Fluids	Excluded
Oil tank, coolers, and breather systems	Excluded
Studs for the purpose of mounting to the chassis or gearbox	Included
Heat Shields	Excluded
Ignition system components supplied with engine	Included
Inlet trumpets	Included

## 4 Homologation

- 4.1 **Homologation** – Only homologated engines may be used during the race season. However, Manufacturer test engines may use unhomologated parts for test purposes.
- 4.2 **Homologation date** – The 2014 Homologation date for the engine is January 31<sup>st</sup> 2014. It is the responsibility of the manufacturers to ensure they work with INDYCAR to achieve homologation in a timely manner.
- 4.3 **Hardware** – Before homologation can be completed, an example of each of the components listed in Appendix D will be made available for inspection and secure storage by INDYCAR. A homologation document must also be completed.
- 4.4 **Bill of Materials** – A full bill of materials with graded parts to be explicitly identified with any alternate part specifications or assemblies must be supplied to INDYCAR.
- 4.5 **Drawings** – Before homologation can be completed, manufacturers will supply hard copies of engineering drawings of the items as shown in Appendix D.
- 4.6 **Torque Sensor** – To assist INDYCAR and ensure compliance with homologation regulations engines selected by INDYCAR will be run with a standard torque sensor that is fed to the INDYCAR-specified ECU for monitoring purposes. The measurement will not be available to anyone except INDYCAR.
- 4.7 **Engine Development** – Table B shows when development changes may be made.

**TABLE B**

Item	Open	2014	2015	2016	Fixed
Chassis mounting points					O
Gearbox mounting points					O
Engine length					O
Deck height					O
Gear train					O
Piston, rings, wrist pins and circlips (including compression ratio)	O				
Crankshaft including journal sizes and Pin angular position					O
Approved coatings/surface treatments	O				
Cylinder block, sump casting and machining, cylinder liners					O
Cylinder head casting, cam cover					O
Cylinder head: valve angles, valve center line spacing, location of intake and exhaust ports relative to the flange face, spark plug location, injector positions, camshaft and journal location,		O			

Item	Open	2014	2015	2016	Fixed
intake/exhaust port shape, combustion chamber shape, valve seat and guide					
Induction system, plenum including connection pipe		O			
Fuel Injection*		O			
Turbo specification including all inlet ducting		O			
Wastegates	O				
Valve train layout					O
Valves, valve springs, retainers and spring seats	O				
Camshaft (lift and duration)		O			
Camshaft blank					O
Connecting rod and bushing		O	O	O	
Lubrication system excluding piston squirt jets					O
All bearing shells and piston squirt jets	O				
Cooling system contained within the engine					O
Spark plugs	O				
Engine auxiliaries including alternator, water and oil scavenge pumps					O

\*Fuel injection is defined as “All parts wetted by the fuel from the engine dry-break to the fuel mixing with the air charge.”

No fabrication work on castings is allowed.

Open items do not need homologating but may be retained and inspected by INDYCAR at any time.

4.8 Parts homologated prior to 2014 may be used through the 2014 Indianapolis 500 Mile Race. At the conclusion of the Indianapolis 500 Mile Race Event, manufacturers must inform INDYCAR whether they are going to continue with 2014 parts only or pre-2014 parts only for any Engines added to the Engine pool after June 1<sup>st</sup> 2014.

4.9 **Reliability, durability and economic fixes** – Permitted at any time at the sole discretion of INDYCAR. A detailed description of such an upgrade will be circulated to all manufacturers who must respond within 5 working days.

4.10 **Performance upgrades** –2 weeks after the Indy 500 and again 2 weeks after the end of the season manufacturers whose engines are statistically more than 4% deficient in power may, at the sole discretion and evaluation of INDYCAR, make improvements to be homologated immediately. These will be introduced only on new engines being sent to the track. These improvements are allowed get the engine up to 2% below the best-performing engine. Should this be exceeded INDYCAR may elect to reduce performance standards to remain within the 2% window by means of boost or RPM control. In assessing this, only measurements accumulated statistically during testing, practice and race conditions will be used.

## 5 Materials

### 5.1 Definitions:

- 5.1.1 *Metal matrix composites* – materials with a matrix material containing a phase of greater than 2%v/v which is not soluble in the liquid phase of the metallic matrix (examples include TiAl (TiAl is permitted for turbocharger turbine wheels)) NiAl, FeAl, Cu<sub>3</sub>Au, NiCo).
- 5.1.2 *Ceramic materials* – these are inorganic, non-metallic solids, examples include Al<sub>2</sub>O<sub>3</sub>, SiC, B<sub>4</sub>C, Ti<sub>5</sub>Si<sub>3</sub>, SiO<sub>2</sub>, Si<sub>3</sub>N<sub>4</sub>.
- 5.1.3 *Inter-metallic materials* – these are materials where the material is based upon inter-metallic phases, i.e. the matrix of the material consist of greater than 50% by weight inter-metallic phase (s). An inter-metallic phase is a solid solution between two or more metals exhibiting either partly ionic or covalent, or metallic bonding with a long range order, in a narrow range of composition around the stoichiometric proportion.

### 5.2 Prohibited materials – Unless explicitly stated the following materials are completely prohibited:

- 1 Magnesium based alloys
- 2 Metal matrix composites (MMC's)
- 3 Inter-metallic materials
- 4 Alloys containing more than 3% by weight of Beryllium, Iridium or Rhenium.

### 5.3 Exceptions:

- a) Except where otherwise stated, coatings and surface treatments are free from material restrictions providing that the coating thickness does not exceed 0.8mm surface thickness
- b) Spark plugs
- c) Hybrid ceramic bearings are permitted in the following locations:
  - 1) Ancillary pumps (coolant and oil system)
  - 2) Gear train
  - 3) Alternator

### 5.4 Mandated component materials –

- 5.4.1 The following components must be made from ferrous alloy:
  - a) All fasteners except connecting rod bolts
  - b) Engine gears including gear hubs
  - c) Piston pin
  - d) Connecting rod and cap (must be the same material)
  - e) Crankshaft

- f) Flywheel
- g) Camshafts (single piece only)

5.4.2 The following **must** be made from monolithic aluminum alloy:

- a) Cylinder head casting (localized enforcement with either composite or MMC is prohibited)
- b) Pistons

5.4.3 The following **must** be made from ferrous, nickel, or titanium alloys:

- a) Valves, valve springs and valve spring seats

5.4.4 The following **must** be made from either monolithic aluminum alloy or a ferrous alloy:

- a) Block casting

5.4.5 Plenums may be made from aluminum, carbon or a combination of either material.

5.5 **Lubricant** – Engines must use only lubricating oil that is commercially and readily available to the general public at a competitive price through normal retail methods. The oil must be approved by INDYCAR before use.

## 6 Fuel Systems

6.1 **Type** – All fuel injectors are to be electrically operated by solenoid mechanisms only.

6.2 **Number of injectors** – A maximum of two injectors per cylinder is allowed of which only one per cylinder may be used for direct injection.

6.3 **Fuel Pressure** – The maximum permitted fuel injection pressure is 300bar.

6.4 **Fuel supply** – INDYCAR will provide more fuel than is necessary to run at peak power mixture for each race (including parade laps).

6.5 **Fuel Composition** – The fuel will be E85 - 85 percent Ethanol, 15 percent gasoline. See Appendix E for details. The fuel must be used as supplied by INDYCAR.

## 7 Turbo-Charger Systems

7.1 **General** – Engines must use two Borg Warner EFR7163 turbochargers with a turbine housing A/R of 0.85. Neither Entrants nor Manufacturers may modify turbochargers in



any way other than changing the connector on the optional speed sensor or changing the thread of the tapped boss on the turbine housing.

- 7.2 **Installation** – One identical turbocharger per cylinder bank; non-sequential operation
- 7.3 **Cooling** – The compressor housing may not be cooled by any method or substance other than the normal heat dissipated from the housing to the atmosphere or by ducted air. Spraying or injecting of any substance into the compressor or onto the compressor housing is prohibited.
- 7.4 **Wastegate Operation** – Up to 2 wastegates may be used per architecture and may be pneumatically or electrically operated but limited to poppet and flap valve types only.
- 7.5 **Integral Wastegates** – Are not permitted.
- 7.6 **Variable Geometry** – Variable geometry turbo charging systems are prohibited.
- 7.7 **Turbocharger life** – Should turbochargers fail to meet the durability targets set by Borg Warner, the manufacturer will take steps to remedy the situation.
- 7.8 **Anti-lag systems** – Prohibited. The engine cylinders must be supplied solely with the air that has exited the turbocharger compressor(s). The turbocharger turbine(s) must be supplied solely with the combustion gases.

## **8 Air Intake**

- 8.1 **Intercooling** – Inter-cooling by any means including fins on the inlet ductwork upstream of the plenum entry or entries is prohibited.
- 8.2 **Inlet Trumpets** – Only fixed-length trumpets are allowed. Adjustment of inlet length may be accomplished by the use of spacers or by fitting alternative lengths of trumpet.
- 8.3 **Variable geometry intake systems** – Any other means of varying the length of the intake (including effective variation of inlet system resonant frequency by additional ductwork or volumes brought into play by valves or other flow regulating means) are prohibited. The intake must contain no moving parts apart from the compressor between the air filter and the plenum entrances.

## 9 Plenum

- 9.1 **Definition** – The induction system is defined as all parts related to the plenum chamber, intake runners, throttle mechanism that can contain the inlet air charge and fuel spray under all race conditions without leaking.
- 9.2 **Plenum** – Only one plenum chamber is permitted. The plenum must be symmetrical side to side from the engine centerline looking from plan view, with the exception of offsetting of the inlet runners to match the engine bank stagger. The only purpose of the ducting between the turbo charger and the inlet plenum manifold must be to channel air. Ducts may not be configured to produce a reduced pressure at the mandated boost sensors. Spraying or injecting of any substance in this duct is prohibited.
- 9.3 **Plenum entrance** – Only one (1) air charge entrance to plenum per turbo charger is permitted. The minimum total air charge entrance area is 10,000mm<sup>2</sup> split equally between the entrances. The ductwork from the compressor outlet to the plenum must have no abrupt changes in direction or section. See Appendix A for details of the plenum pressure sensor location rules.
- 9.4 **Splitters** – Dividing or splitting the plenum into two chambers is prohibited. Turning vanes, vortex generators, panels or splitters which could direct air flow within the plenum chamber are prohibited.
- 9.5 **Cross-section** – Except for the throttle mechanism, inlet runners, fuel injectors, fuel rails, trumpets and typical corner radii, the plenum must be an open space having a constant cross section (perpendicular to the engine center line) excluding plenum entrance. No additional partially closed off volumes to introduce resonances at particular engine speeds are permitted. Inlet runners are to have smooth uninterrupted walls without side branches, except for the purpose of supporting throttle blades, allowing fuel to be injected and for the addition of pressure and temperature sensors.
- 9.6 **External Surface** – The external surfaces of the plenum must remain within the standard Dallara bodywork as delivered with the 2012 car.

## 10 Exhaust Systems

- 10.1 **Exhaust Length** – The exhaust system (including primaries, collector, tail pipe etc.) must be of a fixed length. No moving parts except for the wastegate poppet valves and turbine wheels are allowed between the cylinder head exhaust face and the exhaust tailpipe outlet. Closed-end resonator chambers are prohibited.

- 10.2 **Homologation** – A Manufacturer must homologate at least one exhaust system 30 days prior to the first race. A second exhaust system may be homologated with 30 days' prior approval before its introduction. Homologation shall include the complete system, from the cylinder head exhaust flange to tailpipe exit (All other components are standard parts). Homologated parts may be changed between events only. No changes are permitted during an event weekend without INDYCAR approval.
- 10.3 **Material** – Exhausts may only be manufactured in Inconel.
- 10.4 **Wall Thickness** – All exhaust components must have a minimum wall thickness of 0.032”.

## 11 Engine Throttles

- 11.1 **Throttle Pedal** – The throttle pedal and sensor actuation supplied with the chassis and the sensor specified in Appendix F must be used.
- 11.2 **Torque Control** – The only means by which the driver may control the engine torque is via a single chassis-mounted foot pedal or on-board fuel mixture switch. Designs which allow specific points along the pedal travel range to be identified by the driver or to assist in holding a position are not permitted. The minimum and maximum pedal travel positions must correspond to the engine throttle minimum (normal idle) and maximum open positions.

It is permissible to take control of the engine torque away from the driver during any of these events only:

- a) When a stuck throttle is detected
- b) During a gearshift
- c) For pit lane speed limit control
- d) For engine rev limit control
- e) To control over boosting

- 11.3 **Engine Throttles** – Engine throttling is by port butterfly only and must be located in the intake runner. The number of throttles must equal the number of cylinders. Only one throttle per cylinder is permitted.
- 11.4 **Throttle Angle Variation** – There can be no more than a 2% throttle angle variation bank to bank between the engine throttles at any time.
- 11.5 **Drive-by-wire System** – Drive-by-wire (DBW) by electro-mechanical system only is mandatory. A maximum of one DBW motor per cylinder bank is permitted.

- 11.6 **Throttle Return Spring** – The engine throttles must feature a mechanical spring return mechanism capable of shutting the butterfly throttle in the event of a DBW motor failure.
- 11.7 **Throttle Safety System** – The manufacturer must be able to demonstrate that the systems to detect and react to a stuck throttle condition are effective. These systems must be operational whenever the car runs during an event.

## 12 Control and Logging Systems

- 12.1 **Traction control** – Traction or launch control is not permitted.
- 12.2 **Anti-Stall** – Anti-stall must be set to operate effectively in, at least, 2<sup>nd</sup> and higher gears. The driver may disable it under yellow conditions by using the rotary-switch.
- 12.3 **ECU** – Only the standard TAG-400i ECU, supplied by INDYCAR may be used. No running on track with an unlocked ECU is permitted during any INDYCAR-sanctioned event.
- INDYCAR reserves the right to inspect, draw data from, and withhold any INDYCAR ECU at any time.
- 12.4 **Standard Hardware** – Tampering with the ECU, boost sensor, or torque sensor is forbidden.
- 12.5 **Software** – The control software running within the TAG-400i will be written by McLaren Electronic Systems Ltd (MESL). Engine manufacturers will be able to tune the various maps and configuration parameters to suit the requirements of their engine. Engine builders will be able to develop their own versions based on the race specification software for engine test bed and rig test use.
- 12.6 **Software change requests** – Any software request from an engine manufacturer for implementation at any sanctioned event must be accompanied by a detailed description of its purpose and its intended function. INDYCAR will circulate it to all manufacturers who will have 5 working days to respond. It will then be submitted through the process setup by MESL (web portal). INDYCAR will need to approve it prior to implementation by MESL. In some cases, an approved software request may not be possible for McLaren to implement.
- 12.7 **Firmware** – The INDYCAR specified ECU and GCU-will be mandated containing locked low-level firmware developed by the supplier. It is not permissible to modify the firmware. Any firmware updates will be simultaneously available to all engine manufacturers.

12.8 **Functionality** – Control functionality (and boost monitoring) may reside within the engine ECU, clutch control unit (CCU) and the gearbox control unit (GCU) only. No driver box, such as injector driver, ignition driver, DBW motor driver, or wastegate actuator may provide any control function.

The INDYCAR-specified ECU will provide a bi-directional data link for on-board car data logging and an additional link for the dashboard. The assignment of the data channels is open to specification by the engine manufacturer.

12.9 **Function adjustment** – Any selection of or adjustments to control functions must be initiated by the driver via on-board switches only.

12.10 **Two-way telemetry** – Two-way telemetry or remote control of any software function while the racecar is on track is prohibited.

12.11 **Pit lane Speed Control** – The driver only must initiate pit lane speed control activation and deactivation.

12.12 **Boost Pressure** – The application layer software for monitoring the plenum pressure via the two series supplied transducers (pressure levels as in 3.4) is controlled by INDYCAR. The penalty for over boosting will be determined by INDYCAR.

12.13 **Rev Limiter** – The application layer software for imposing the series rev limit is controlled by INDYCAR.

12.14 **Quarantine** – INDYCAR reserves the right to quarantine ECU's in its sole discretion.

12.15 **Fuel Mixture Switch** – A single switch to be within the cockpit and controlled only by the driver. It may have a maximum of eight (8) positions.

12.16 **Crankshaft Speed Sensor** – A McLaren Electronics Inc. crank sensor is mandated – see appendix G. Any attempt to interfere with or modify the signal from these sensors as seen by the ECU will be subject to penalties.

12.17 **Wiring** – Engine loom and interface loom wiring must be approved by INDYCAR before being used in an INDYCAR-sanctioned event.

## 13 Transmission

13.1 **General** – The transmission, including the clutch mechanism, is provided as part of the safety cell/rolling chassis and as such is standard for all competitors. It features gear actuation by the Series-specified pneumatic system.

13.2 **Control** – Control for the gearshift system will be through the INDYCAR-approved engine ECU only.

## Appendix A

### Boost sensor location

1. Two, single-channel sensors as provided by INDYCAR are required per installation.
2. Each sensor must be mounted on the same face of the plenum as and coplanar with a plenum inlet. Adjacent to each plenum entrance must be a flat area of minimum dimensions of 55mm x 25mm on the same plane as the joint between the duct and plenum and between  $90^\circ \pm 20^\circ$  to the locus of the centroid of the last 15mm of the duct cross-sectional area. These flat areas will be used as mounting locations for the INDYCAR-supplied plenum pressure sensors.
3. Sensors must be located within 50mm of the nearest point of the junction between the plenum inlet(s) and the inner surface of the plenum.
4. Sensors must be located at least 30mm away from any portion of the engine inlet trumpets (see below).
5. Plenum must have a  $\text{Ø}4.00\text{mm} \pm 0.1\text{mm}$  orifice to mate with the sensing port of each sensor and the mounting face of the sensor must be no less than 11.0mm from the inner surface of the plenum. The axis of this hole will be  $90^\circ$  to the flat area surface. The inside of the plenum where the sensor mounts will be flat  $\pm 0.1\text{mm}$  within 15mm of the axis of the hole.
6. Sensors must be easily accessible without the removal of any other engine components.

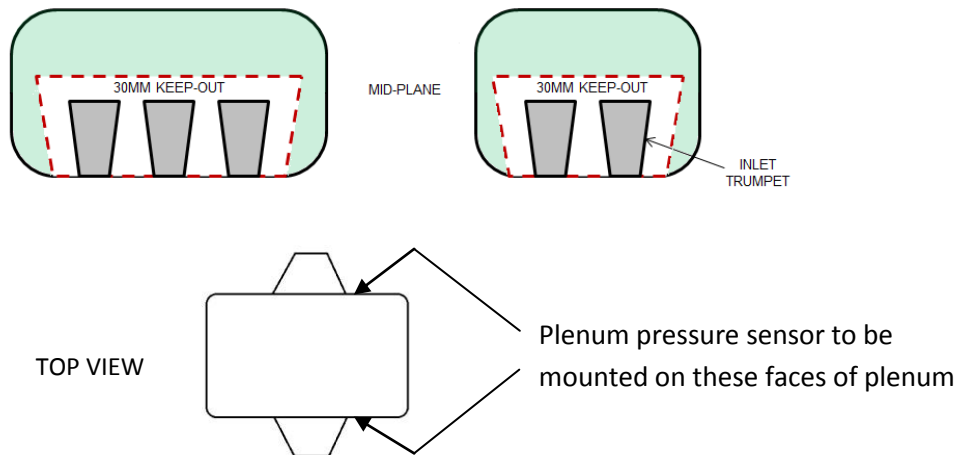

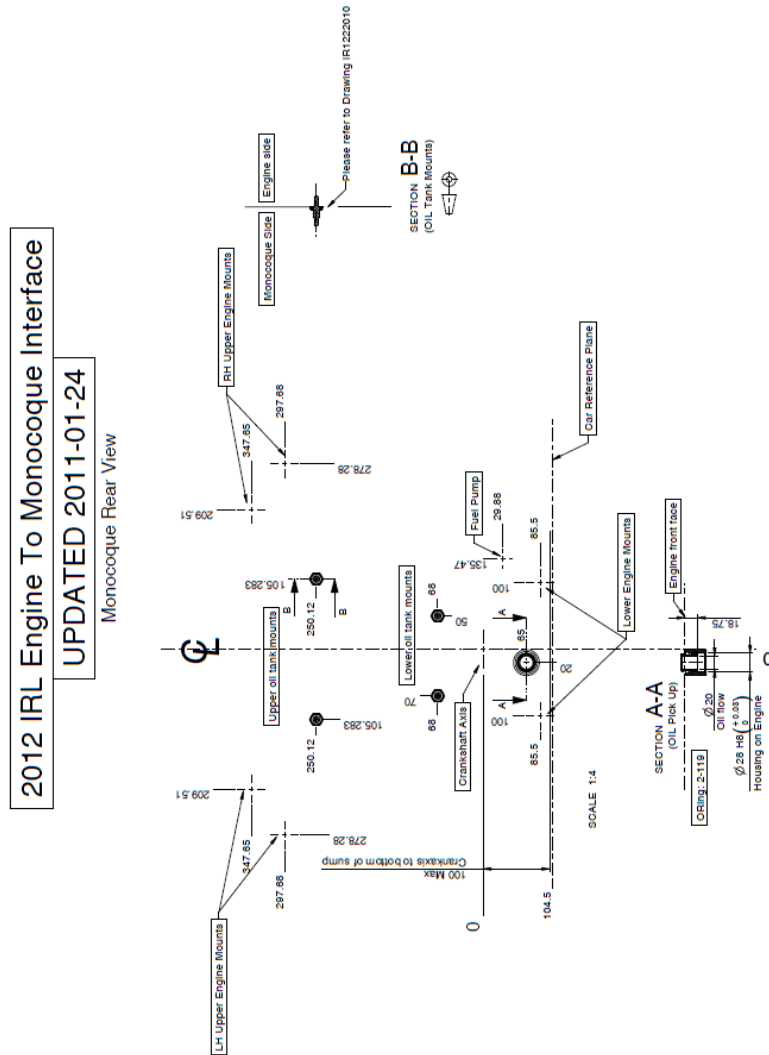



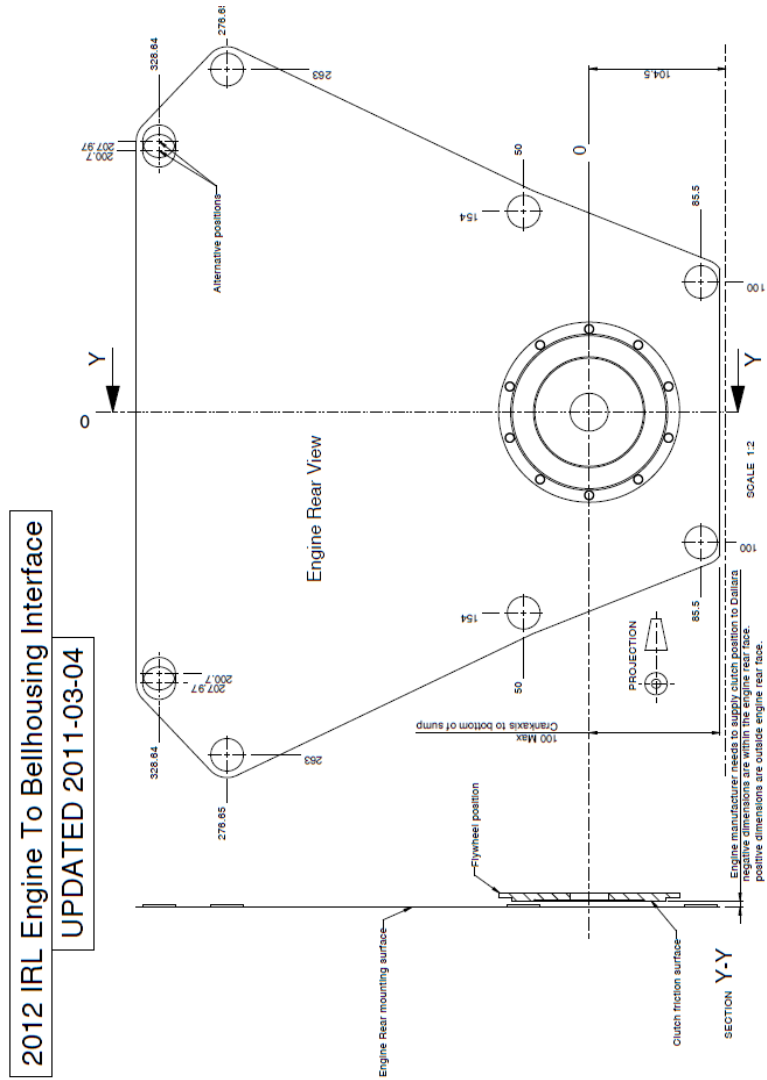

## Appendix D      Reference components

The following components will be held in secure storage: -

Left and right cylinder heads complete with one cylinder's valves, cam followers, cam bearings and camshafts. These are to be fitted using light springs, not the production valve springs, to allow valve lift vs. camshaft angle to be measured.

Cylinder block including sump

Plenum upper and lower

Compressor inlet and outlet air ducts

An example of each different design of fuel injector – Indirect and direct

Hard copies of drawings of the following component will be held in secure storage: -

Piston sleeve

Connecting rod

Crankshaft

Inlet and exhaust manifold faces of cylinder head

Inlet and Exhaust camshaft blank

Rockers

Inlet and Exhaust valve lift profile

Inlet manifold

Throttle body and butterfly

Fuel rails – Indirect and direct

Engine loom(s)

Interface loom

## Appendix E      Sunoco E85-R Typical Properties

Color	pale green
Octane Number (R+M)/2	99 (estimated)
Specific Gravity	0.79
Density (lbs/gal)	6.6
Reid Vapor Pressure (psi)	5
ASTM D86 Distillation (deg F)	
Initial Boiling Point	130
10% Evaporated	165
50% Evaporated	171
90% Evaporated	173
Final Boiling Point	180
H/C Ratio	2.74
O/C Ratio	0.39
Stoichiometric Air/Fuel Ratio	9.8:1
Oxygen (weight %)	29

## **Appendix F          Throttle Pedal Position Sensor Specification**

Cosworth part no. 21A-0180

Hall Effect

0.5V = 0°

30° = 4.5V

D-shaped interface

Twin-track, opposing electronic range

Appendix G

McLaren Crank Speed Sensor Specification

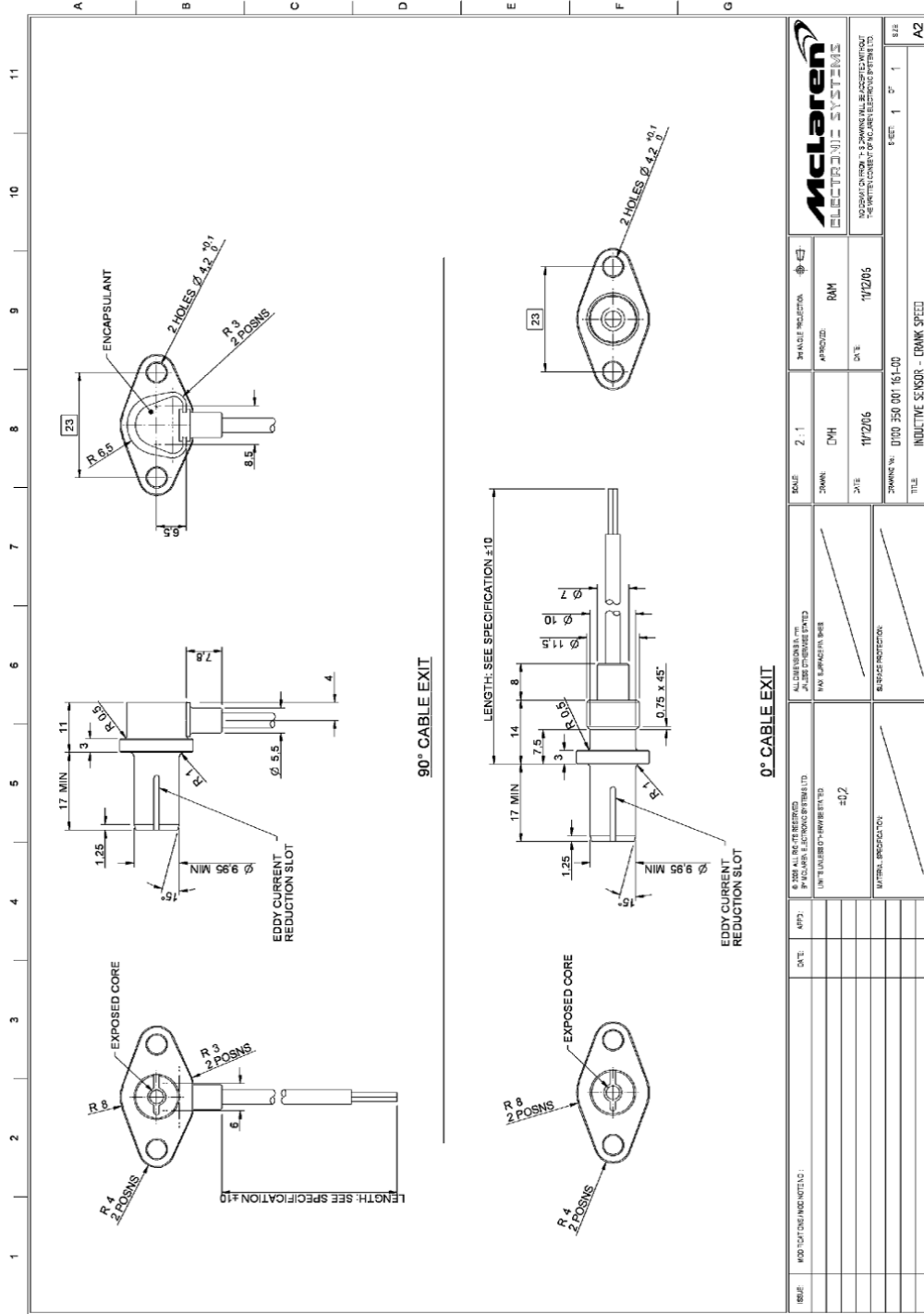

<p>McLaren ELECTRONIC SYSTEMS</p> <p>MOTORSPORT DIVISION - 3, SPAINING VALLE, LAZARPIDO, P.O. BOX 1001, C/ EL MONTE, 28150 CALZADILLA DE ALCAZALEDES</p>		<p>SCALE: 2:1</p> <p>DRAWN: DMH</p> <p>DATE: 11/2006</p> <p>DWG NO: D100 350 001 161-00</p> <p>TITLE: INDUCTIVE SENSOR - CRANK SPEED</p>	<p>APPROVED: BMM</p> <p>DATE: 11/2006</p> <p>REV: 1</p>	<p>INDUCTION PROTECTION</p> <p>APPROVED: BMM</p>	<p>DATE: 11/2006</p> <p>REV: 1</p>
<p>NO SCALE</p> <p>DATE: 11/2006</p> <p>REV: 1</p>	<p>DATE: 11/2006</p> <p>REV: 1</p>	<p>DATE: 11/2006</p> <p>REV: 1</p>	<p>DATE: 11/2006</p> <p>REV: 1</p>	<p>DATE: 11/2006</p> <p>REV: 1</p>	<p>DATE: 11/2006</p> <p>REV: 1</p>
<p>DATE: 11/2006</p> <p>REV: 1</p>	<p>DATE: 11/2006</p> <p>REV: 1</p>	<p>DATE: 11/2006</p> <p>REV: 1</p>	<p>DATE: 11/2006</p> <p>REV: 1</p>	<p>DATE: 11/2006</p> <p>REV: 1</p>	<p>DATE: 11/2006</p> <p>REV: 1</p>
<p>DATE: 11/2006</p> <p>REV: 1</p>	<p>DATE: 11/2006</p> <p>REV: 1</p>	<p>DATE: 11/2006</p> <p>REV: 1</p>	<p>DATE: 11/2006</p> <p>REV: 1</p>	<p>DATE: 11/2006</p> <p>REV: 1</p>	<p>DATE: 11/2006</p> <p>REV: 1</p>
<p>DATE: 11/2006</p> <p>REV: 1</p>	<p>DATE: 11/2006</p> <p>REV: 1</p>	<p>DATE: 11/2006</p> <p>REV: 1</p>	<p>DATE: 11/2006</p> <p>REV: 1</p>	<p>DATE: 11/2006</p> <p>REV: 1</p>	<p>DATE: 11/2006</p> <p>REV: 1</p>
<p>DATE: 11/2006</p> <p>REV: 1</p>	<p>DATE: 11/2006</p> <p>REV: 1</p>	<p>DATE: 11/2006</p> <p>REV: 1</p>	<p>DATE: 11/2006</p> <p>REV: 1</p>	<p>DATE: 11/2006</p> <p>REV: 1</p>	<p>DATE: 11/2006</p> <p>REV: 1</p>
<p>DATE: 11/2006</p> <p>REV: 1</p>	<p>DATE: 11/2006</p> <p>REV: 1</p>	<p>DATE: 11/2006</p> <p>REV: 1</p>	<p>DATE: 11/2006</p> <p>REV: 1</p>	<p>DATE: 11/2006</p> <p>REV: 1</p>	<p>DATE: 11/2006</p> <p>REV: 1</p>
<p>DATE: 11/2006</p> <p>REV: 1</p>	<p>DATE: 11/2006</p> <p>REV: 1</p>	<p>DATE: 11/2006</p> <p>REV: 1</p>	<p>DATE: 11/2006</p> <p>REV: 1</p>	<p>DATE: 11/2006</p> <p>REV: 1</p>	<p>DATE: 11/2006</p> <p>REV: 1</p>
<p>DATE: 11/2006</p> <p>REV: 1</p>	<p>DATE: 11/2006</p> <p>REV: 1</p>	<p>DATE: 11/2006</p> <p>REV: 1</p>	<p>DATE: 11/2006</p> <p>REV: 1</p>	<p>DATE: 11/2006</p> <p>REV: 1</p>	<p>DATE: 11/2006</p> <p>REV: 1</p>
<p>DATE: 11/2006</p> <p>REV: 1</p>	<p>DATE: 11/2006</p> <p>REV: 1</p>	<p>DATE: 11/2006</p> <p>REV: 1</p>	<p>DATE: 11/2006</p> <p>REV: 1</p>	<p>DATE: 11/2006</p> <p>REV: 1</p>	<p>DATE: 11/2006</p> <p>REV: 1</p>
<p>DATE: 11/2006</p> <p>REV: 1</p>	<p>DATE: 11/2006</p> <p>REV: 1</p>	<p>DATE: 11/2006</p> <p>REV: 1</p>	<p>DATE: 11/2006</p> <p>REV: 1</p>	<p>DATE: 11/2006</p> <p>REV: 1</p>	<p>DATE: 11/2006</p> <p>REV: 1</p>